

gie el.

Gie El to meble, oświetlenie i dodatki do wyposażania wnętrz. Poszukujemy, projektujemy i odkrywamy piękne przedmioty dla domu i wnętrza, oferując proste, oryginalne i ponadczasowe produkty oraz dobrze skrojony design. Łączymy nowoczesne trendy wyposażenia wnętrz i zakorzenione w tradycji rzemiosło. Inspiracje czerpiemy z natury, otaczającego świata i piękna prostych, codziennych rzeczy. Nazwę Gie El zaczerpnęliśmy od łacińskiej frazy Genius Loci, oznaczającej opiekuńczego ducha miejsca. Duch ten obecny jest w przestrzeniach i rzeczach, które nas otaczają, sprawiając, że są unikatowe i jedyne w swoim rodzaju.

Gie El is a contemporary brand focused on creating furniture, lighting and accessories for decoration of interiors. We search, design and discover beautiful items for the home and interiors, offering simple, original and timeless products and a well-tailored design. We combine modern trends in home furnishing and the craft rooted in tradition. We draw the inspiration from nature, the surrounding world and the beauty of simple, everyday objects. Name Gie El was taken from latin frase Genius Loci. It refers to a location's distinctive atmosphere and a spint of place that takes care of surrounding space, interiors, objects, making them being unique.



LAMPY WISZĄCE	_10
ZYRANDOLE	_82
KINKIETY	_118
LAMPY STOŁOWE	_128
LAMPY PODŁOGOWE	_154
TECHNICZNE	_176

PENDANT LAMPS	_10
CHANDELIERS	_82
WALL LAMPS	_118
TABLE LAMPS	_128
FLOOR LAMPS	_154
TECHNICAL	_176



_12



_14



_17



_18

_21



_43



_44



_47



_48



_22



_26



_52



_56



_60



_63



_29



_25



_30



_66



_69



_70



_34

_37

_38

_41

_76

_77

_78

_13

LAMPY WISZĄCE _ PENDANT LAMPS



LGH0531

LGH0530



LGH0533

LGH0534

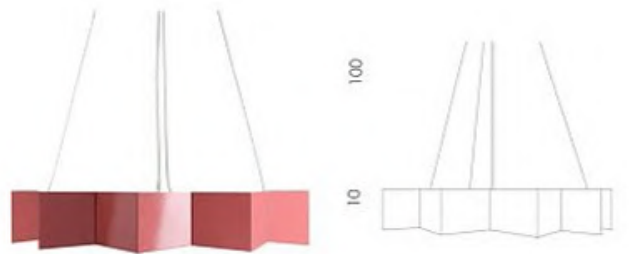

LGH0535

55

PROJEKTANT: MAGDA KOSTYRA
KRAJ PRODUKCJI: POLSKA
TYP ŻARWIŚKI: D
WZÓRNIK: E27
ŻARWIŃKA NIE DOŁĄCZONA
PRZEWÓD: PCV - PRZEJRYSTY
MATERIAŁ: METAL

DESIGNER: MAGDA KOSTYRA
COUNTRY OF ORIGIN: POLAND
SUNG TYPE: D
SOCKET: E27
BULB NOT INCLUDED
CORD: PCV - TRANSPARENT
MATERIAL: METAL



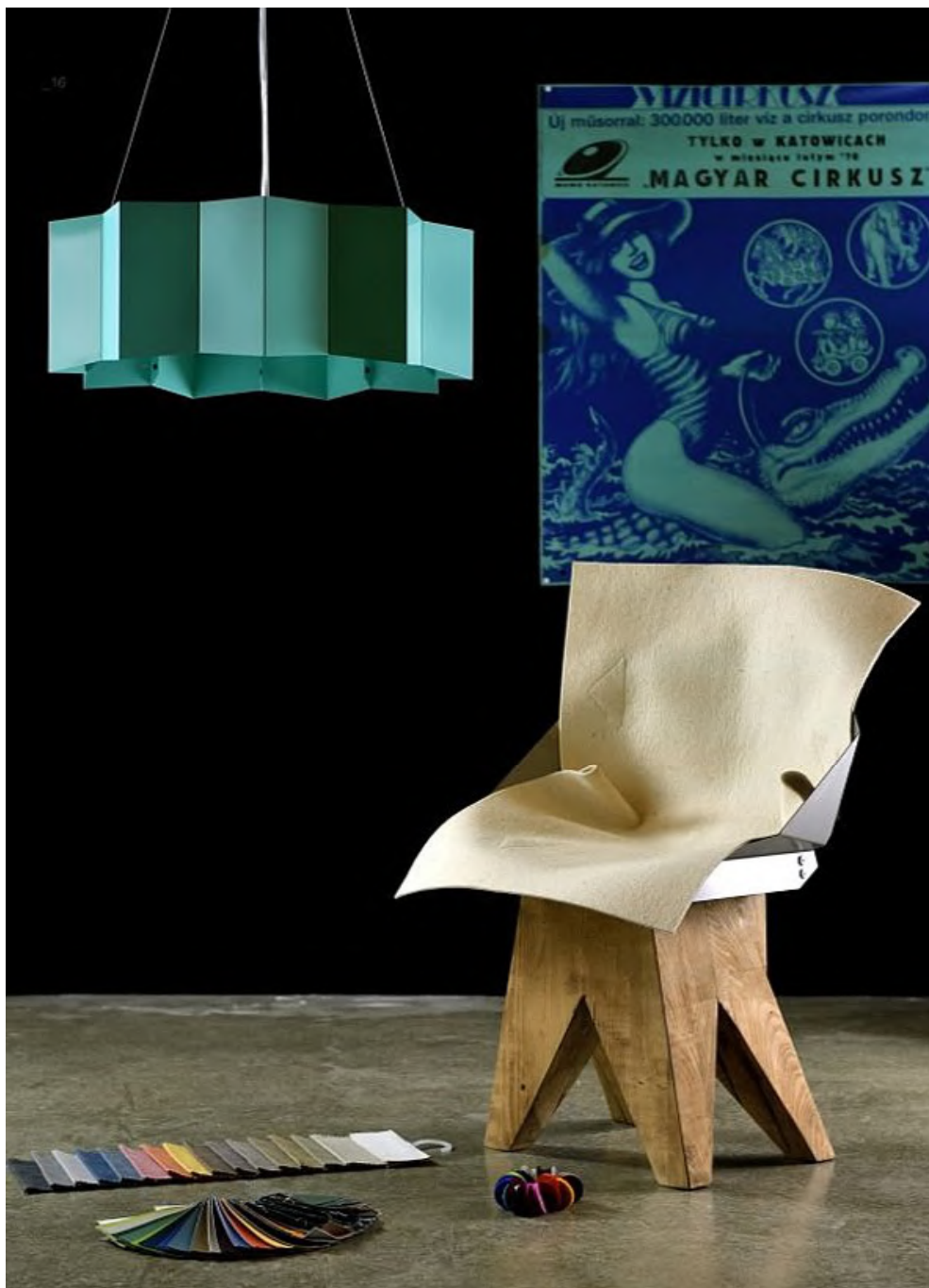

LGH0540



LGH0541



LGH0544



LGH0543

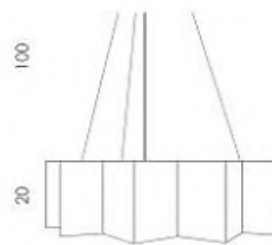

55



LGH0545

PROJEKTANT: MAGDA KOSTYRA
 KRAJ PRODUKCJI: POLSKA
 TYPI ZAWIESKA: D
 TRZONKÓW: E27
 ŻARÓWKI NIE DOŁĄCZONA
 PRZEWÓD: PCV - PRZEJRZYSTY
 MATERIAŁ: METAL

DESIGNER: MAGDA KOSTYRA
 COUNTRY OF ORIGIN: POLAND
 SLING TYPE: D
 SOCKET: E27
 BULB NOT INCLUDED
 CORD: PCV - TRANSPARENT
 MATERIAL: METAL

_18

HĄT



LGH0145



LGH0143



LGH0144

KRAJ PRODUKCJI: POLSKA
 TYP ZAWIESA: C.1, C.4, C.5
 TECHNIK: E27
 ŻARÓWKI: NIE DOKŁĄCZONA
 PRZEWÓD: PCV - TRANSPARENTNY
 TEKSTYL: CZARNY, BIAŁY
 MATERIAŁ: METAL

COUNTRY OF ORIGIN: POLAND
 SLING TYPE: C.1, C.4, C.5
 SOCKET: E27
 BULB NOT INCLUDED
 CORD: PCV - TRANSPARENT
 TEXTILE - BLACK, WHITE
 MATERIAL: METAL

_19





LGH0770



LGH0771

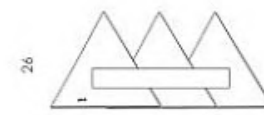
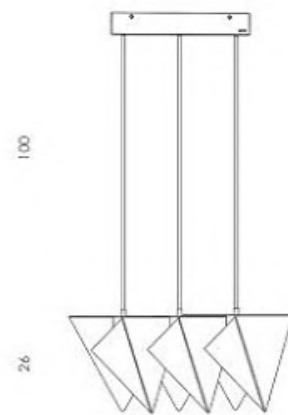

PROJEKTANT: JACEK RYPIULA
 MONIKA FLUTA
 GRAJ PRODUKCJA: POLSKA
 TYP ZAWIESIA: E.1, E.2
 TRZONKIEK: 3xØ27
 ŻARÓWKA NIE DOŁĄCZONA
 PRZEWÓD: TEKSTYLNÝ -
 CZARNÝ, ŻEBRA
 MATERIAŁ: METAL

DESIGNER: JACEK RYPIULA
 MONIKA FLUTA
 COUNTRY OF ORIGIN: POLAND
 SLING TYPE: E.1, E.2
 SOCKET: 3xØ27
 BULB NOT INCLUDED
 CORD: TEXTILE - BLACK, ZEBRA
 MATERIAL: METAL



LGH0761



LGH0760



100

26

49



49

49

PROJEKTANT: JACEK RYPUŁA
 MONIKA PŁUŚA
 KRAJ PRODUKCJI: POLSKA
 TYP ŻAWEŚA: N.1
 PRZEMOC: 3x227
 ŻARÓWKA NIE DOŁĄCZONA
 PRZEWÓD: TEKSTYLNÝ - CZARNY, ŻEBRA
 MATERIAŁ: METAL

DESIGNER: JACEK RYPUŁA
 MONIKA PŁUŚA
 COUNTRY OF ORIGIN: POLAND
 SLING TYPE: N.1
 SOCKETS: 3x227 / BULB NOT INCLUDED
 CORD: TEXTILE - BLACK, ZEBRA
 MATERIAL: METAL



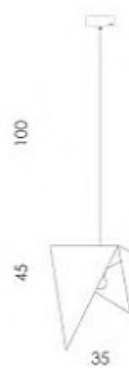

PROJEKTANT: JACEK RYPIŃA
KRAJ PRODUKCJI: POLSKA
WYKONANIE: C
TRZONKI: E27
ŻARÓWKI: NIE DOŁĄCZONA
PRZEWÓD: TEKSTYLNÝ - CZARNY,
BIŁY, PCV - PRZEJRYSTY
MATERIAŁ: METAL

DESIGNER: JACEK RYPIŃA
COUNTRY OF ORIGIN: POLAND
SLING TYPE: C
SOCKET: E27
BULB: NOT INCLUDED
CORD: TEXTILE - BLACK,
WHITE, PCV - TRANSPARENT
MATERIAL: METAL



LGH0311



LGH0310



LGH0643



LGH0641



LGH0551

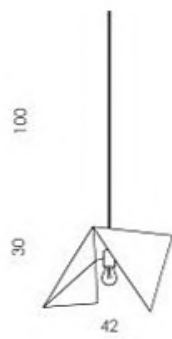

PROJEKTANT: JACEK RYPUŁA
KRAJ PRODUKCJI: POLSKA
TYP ZAWIESKI: C
BŁONKIE: E27
ŻARÓWKIŁA DOLĄCZONA
PRZEWÓD: TEKSTYLNÝ - CZARNÝ,
BIŁY, PCV - PRZEJRYSTY
MATERIAŁ: METAL

DESIGNER: JACEK RYPUŁA
COUNTRY OF ORIGIN: POLAND
SUNG TYPE: C
SOCKET: E27
BULB NOT INCLUDED
CORD: TEXTILE - BLACK, WHITE,
PCV - TRANSPARENT
MATERIAL: METAL





LGH0750



LGH0751

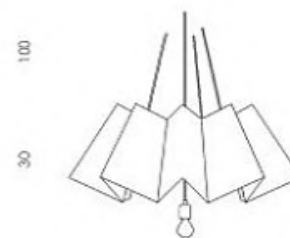

75

PROJEKTANT: JACEK RYPUŁA
 DAWA STANCIK
 KRAJ PRODUKCJI: POLSKA
 TYP ŻAWEŚA: D.2, D.3
 TRZONEK: E27
 ŻARÓWKA NIE DOŁĄCZONA
 PRZEWÓD: PCV - PRZEJRYSTY
 MATERIAŁ: METAL

DESIGNER: JACEK RYPUŁA
 DAWA STANCIK
 COUNTRY OF ORIGIN: POLAND
 SUNG TYPE: D.2, D.3
 SOCKET: E27
 BULB NOT INCLUDED
 CORD: PCV - TRANSPARENT
 MATERIAL: METAL

_30

RECT



LGH0811



LGH0810

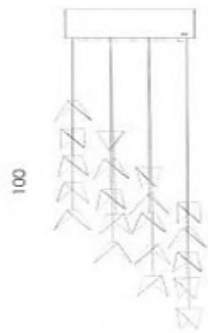

100

46

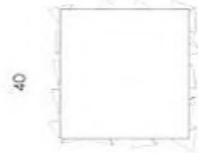

40

40

PROJEKTANT: JACEK RYPUŁA
 MONIKA PUSTA
 KRAJ PRODUKCJI: POLSKA
 TYP ŻAWEŚLA: L1, L2
 TRZONKIE: 15x9
 ŻARÓWKI NE DOLĄCZONE
 MATERIAŁ: METAL

DESIGNER: JACEK RYPUŁA
 MONIKA PUSTA
 COUNTRY OF ORIGIN: POLAND
 SLING TYPE: L1, L2
 SOCKET: 15x9
 BULBS NOT INCLUDED
 MATERIAL: METAL

_31





LGH0840

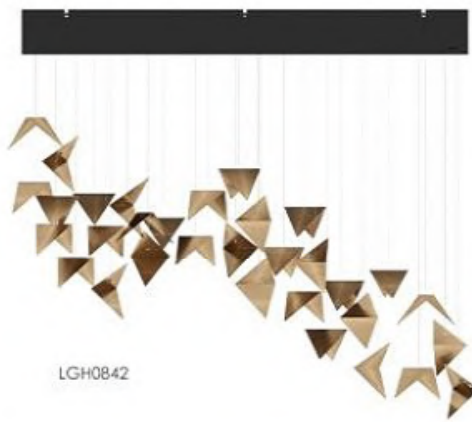

LGH0842



LGH0841

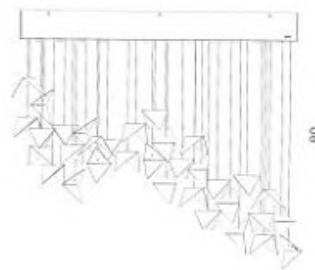

80



90

90

90

PROJEKTANT: JACEK RYPULA
 MONIKA FLUTA
 KRAJ PRODUKCJI: POLSKA
 TYPI ZAWIESIANKI: M.1, M.2
 TRZONKI: 12x60
 ŻARÓWKI NIE DOŁĄCZONE
 MATERIAŁ: METAL

DESIGNER: JACEK RYPULA
 MONIKA FLUTA
 COUNTRY OF ORIGIN: POLAND
 SLING TYPE: M.1, M.2
 SOCKET: E27/E29
 BULBS NOT INCLUDED
 MATERIAL: METAL



LGH0852



LGH0851



LGH0850

PROJEKTANT: JACEK RYPUŁA
MONIKA PUŁA
KRAJ PRODUKCJI: POLSKA
TYP ZAWIESKI: M.1, M.2
WZROK: 12KG9
ŻARÓWKI NIE DOLĄCZONE
MATERIAŁ: METAL

DESIGNER: JACEK RYPUŁA
MONIKA PUŁA
COUNTRY OF ORIGIN: POLAND
SLING TYPE: M.1, M.2
SOCKET: 12KG9
BULBS NOT INCLUDED
MATERIAL: METAL

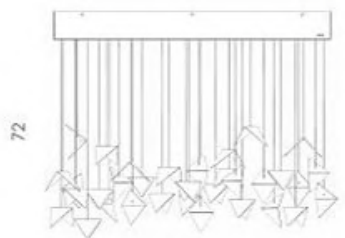

72

90



19

90





36



LGH0821



LGH0820

37

HIVE

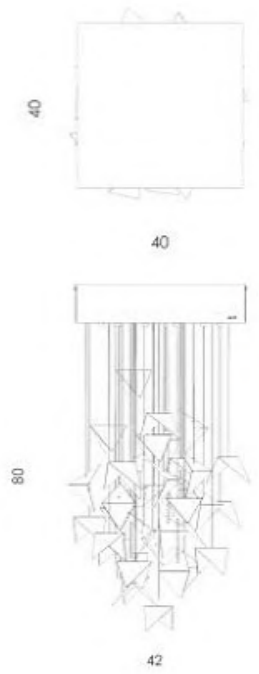

80

40

40

42



LGH0822

PROJEKTANT: JACEK RYPUA
 MONIKA FLUTA
 KRAJ PRODUKCJI: POLSKA
 TYP ZAWIESIA: L3, L4
 TRZONKI: 12x69
 ZARÓWKI NE DODACZNE
 MATERIAŁ: METAL

DESIGNER: JACEK RYPUA
 MONIKA FLUTA
 COUNTRY OF ORIGIN: POLAND
 SING FYPE: L3, L4
 SOCKET: E27/E29
 BULBS NOT INCLUDED
 MATERIAL: METAL



LGH0831



LGH0830

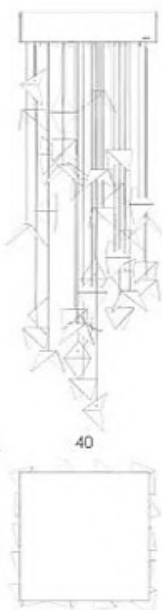

120

40

40

PROJEKTANT: JACEK R.
MONIKA PUSTA
KRAJ PRODUKCJI: POL
TYP ZAWIESIA: L1, L2
PRZEZNACZENIE: 15WGP
ZARÓWNIEM DOLACZONY
MATERIAŁ: METAL

DESIGNER: JACEK RYPULA
MONIKA PUSTA
COUNTRY OF ORIGIN: PO
SUNG TYPE: L1, L2
SOCKET: 15WGP
BULBS NOT INCLUDED
MATERIAL: METAL



LGH0832





LGH0430

LGH0431

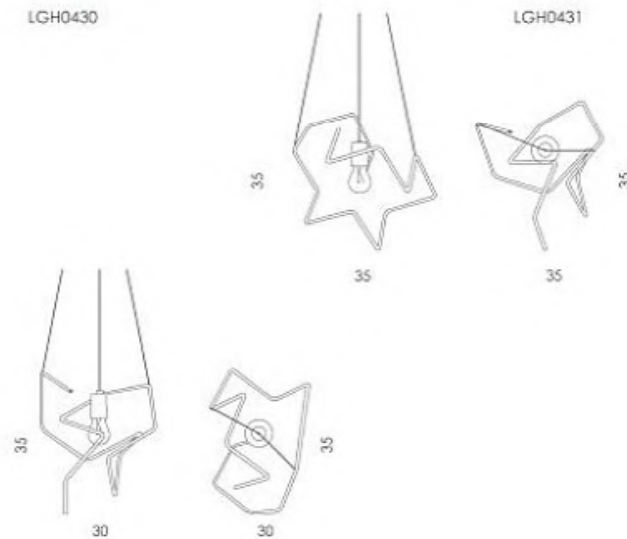

PROJEKTANT: JACEK RYPIŃA
 KRAJ PRODUKCJI: POLSKA
 TYP ŻARÓWKI: D.1
 PRZEMEK: E27
 ŻARÓWKI NIE DOŁĄCZONA
 PRZEWOD: PCV - PRZEJRYSTY
 MATERIAŁ: MIEDŹ

DESIGNER: JACEK RYPIŃA
 COUNTRY OF ORIGIN: POLAND
 LAMP TYPE: D.1
 SOCKET: E27
 BULB NOT INCLUDED
 CORD: PCV - TRANSPARENT
 MATERIAL: COPPER



LGH0060



LGH0061



LGH0062

43
BEE

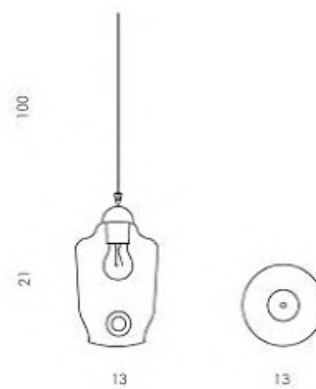

PROJEKTANT: MARIA RYPUŁA
 JACEK RYPUŁA
 KRAJ PRODUKCJI: POLSKA
 TYP ZAWIESIA: C.3
 TRZONKIEK: E27
 ŻARÓWKA NIE DOŁĄCZONA
 PRZEWÓD: PCV - PRZEJRYŚLIWY
 MATERIAŁ: BEZCIEPNE WYTWARZANE SZKŁO

DESIGNER: MARIA RYPUŁA
 JACEK RYPUŁA
 COUNTRY OF ORIGIN: POLAND
 HUNG: C.3
 SOCKET: E27
 BULB NOT INCLUDED
 CORD: PCV - TRANSPARENT
 MATERIAL: HAND MADE GLASS



LGH0490



LGH0491



LGH0492

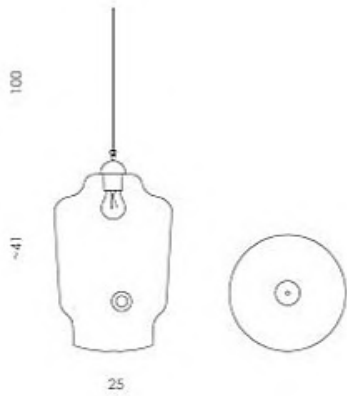

PROJEKTANT: MARIA RYPULA
 JACEK RYPULA
 KRAJ PROJEKCJI: POLSKA
 TYP ZAWIESKI: A.1
 REGION: E27
 ŻARÓWKA NIE DOŁĄCZONA
 PRZEWÓD: PCV - PRZEJRZYSTY
 MATERIAŁ: RĘCZNE WYTWARZANE SZKŁO

DESIGNER: MARIA RYPULA
 JACEK RYPULA
 COUNTRY OF ORIGIN: POLAND
 SENG TYPE: A.1
 SOCKET: E27
 BULB NOT INCLUDED
 CORD: PCV - TRANSPARENT
 MATERIAL: HAND MADE GLASS





LGH0100



LGH0101



LGH0102

47
BEE



PROJEKTANT: MARIA RYPUŁA
JACZEK RYPUŁA
KRAJ PRODUKCJI: POLSKA
TYP ZAWIESI: A.1
TRZEMIEK: E27
ŻARÓWKA NIE DOŁĄCZONA
PRZEWÓD: PCV - PRZEJRYŚLIWY
MATERIAŁ: RĘCZNIE WYTWARZANE SZKŁO

DESIGNER: MARIA RYPUŁA
JACZEK RYPUŁA
COUNTRY OF ORIGIN: POLAND
SLING TYPE: A.1
SOCKET: E27
BULB NOT INCLUDED
CORD: PCV - TRANSPARENT
MATERIAL: HAND MADE GLASS



LGH0403



LGH0402



LGH0401



LGH0400

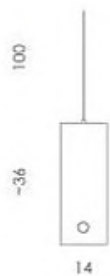

KRAJ PRODUKCJI: POLSKA
 TYP ZAWIESI: C.5
 PRZECIĘCIE: E27
 ŻARÓWKA NIE DOŁĄCZONA
 PRZEWÓD: TEKSTYLNÝ - CZARNY
 MATERIAŁ: RĘCZNIE WYTWARZANE SZKŁO

COUNTRY OF ORIGIN: POLAND
 HUNG TYPE: C.5
 SOCKET: E27
 BULB NOT INCLUDED
 CORD: TEXTILE - BLACK
 MATERIAL: HAND MADE GLASS



_50
Z
O



LGH0413



LGH0412



LGH0422



LGH0423

_51
Z
O



LGH0411



LGH0410



LGH0420



LGH0421

KRAJ PRODUKCJI: POLSKA
TYP ZAWEŚIA: C.5
ŻEŁWIENIE: E27
ŻARÓWKI NIE DOŁĄCZONA
PRZEWÓD TEKSTYLNY - CZARNY
MATERIAŁ: RĘCZNE WYTWARZANE SZKŁO

COUNTRY OF ORIGIN: POLAND
HUNG TYPE: C.5
SOCKET: E27
BULBS NOT INCLUDED
CORD: TEXTILE - BLACK
MATERIAL: HAND MADE GLASS

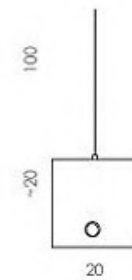
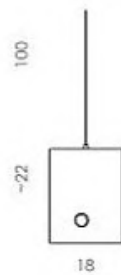



LGH0257



LGH0256



LGH0254



LGH0258



LGH0255

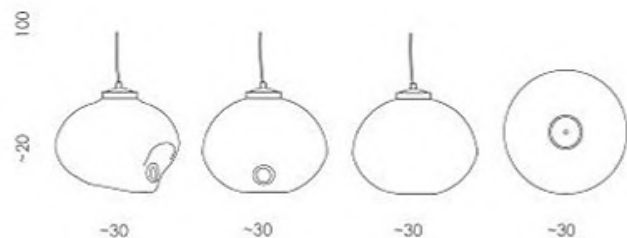

PROJEKTANT: MARIA RYPUŁA
 JACEK RYPUŁA
 KRAJ PROJEKTANTA: POLSKA
 TYP ZAWEŚKI: A.1
 WZŁONIEK: E27
 ŻARÓWKI NIE DOKŁADZONA
 PRZEWÓD: PCV - PRZEKRZYTY
 MATERIAŁ: RĘCZNE WYTWARZANE SZKŁO

DESIGNER: MARIA RYPUŁA
 JACEK RYPUŁA
 COUNTRY OF ORIGIN: POLAND
 SLING TYPE: A.1
 SOCKET: E27
 BULB NOT INCLUDED
 CORD: PCV - TRANSPARENT
 MATERIAL: HAND MADE GLASS





LGH0250



LGH0251



LGH0253



LGH0252

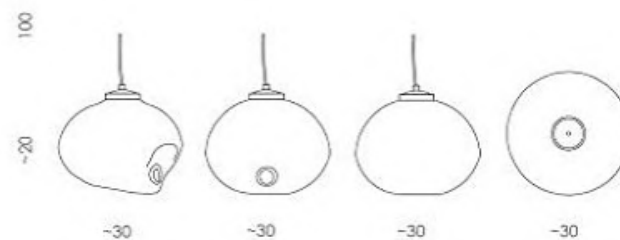

PROJEKTANT: JACEK RYPUŁA
 KRAJ PRODUKCJI: POLSKA
 TYP ZAWIESI: C.6
 TRZEMNIK: E27
 ŻARÓWKI: NIE DOŁĄCZONA
 PRZEWÓD: W OPCIJCE - ŻEBRA
 MATERIAŁ: RĘCZNIE WYTWARZANE SZKŁO

DESIGNER: JACEK RYPUŁA
 COUNTRY OF ORIGIN: POLAND
 SLINGTYPE: C.6
 SOCKET: E27
 BULB NOT INCLUDED
 CORD: TEXTILE - ZEBRA
 MATERIAL: HAND MADE GLASS



LGH0264



LGH0265



LGH0266

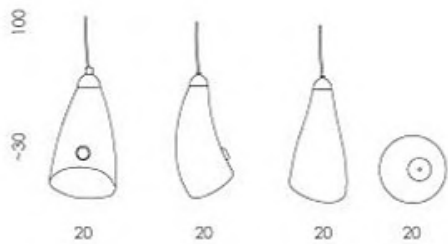

PROJEKTANT: JACEK RYPULA
KRAJ PRODUKCJI: POLSKA
TYP ŻARWIŚKI: C.3
BZCZNIK: E27
ŻARWIŚKA NIE DOŁĄCZONA.
PRZEWÓD: PCV - PRZEJRZYSTY
MATERIAŁ RĘCZNIE WYTWARZANE SZKŁO

DESIGNER: JACEK RYPULA
COUNTRY OF ORIGIN: POLAND
LAMP TYPE: C.3
SOCKET: E27
BULB NOT INCLUDED
CORD: PCV - TRANSPARENT
MATERIAL: HAND MADE GLASS





LGH0260



LGH0261



LGH0262



LGH0263

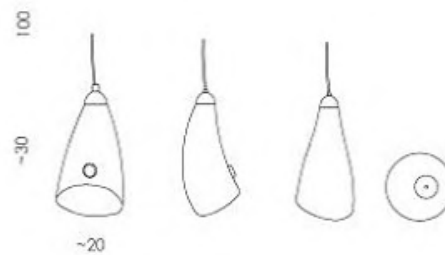

PROJEKTANT: JACEK RYPIŃA
 KRAJ PRODUKCJI: POLSKA
 TYP ZAKRESA: C 6
 WZÓRNEK: E27
 ŻARÓWKA NIEM. DOLĄCZONA
 PRZEWÓD: W OPCIJIE - ZEBRA
 MATERIAŁ: RĘCZNIE WYTWARZANE SZKŁO

DESIGNER: JACEK RYPIŃA
 COUNTRY OF ORIGIN: POLAND
 SLING TYPE: C 6
 SOCKET: E27
 BULB NOT INCLUDED
 CORD: TEXTILE - ZEBRA
 MATERIAL: HAND MADE GLASS



LGH0620

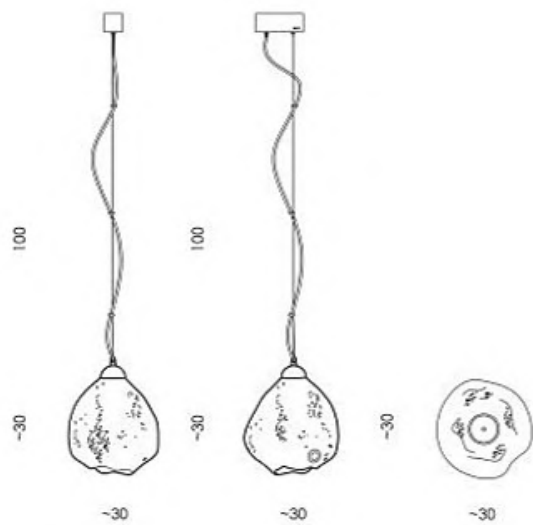

PROJEKTANT: MARIA RYPULA
 KRAJ PRODUKCJI: POLSKA
 TIP ZAKRESIA: A.1
 SZEROKOŚĆ: E27
 ŻARÓWKI: NIEM. DOLĄCZONA
 PRZEWÓD: PCV, PRZECIŻYSTY
 MATERIAŁ: RĘCZNE WYTWARZANE SZKŁO

DESIGNER: MARIA RYPULA
 COUNTRY OF ORIGIN: POLAND
 SING TYPE: A.1
 SOCKET: E27
 BULB NOT INCLUDED
 PCV: TRANSPARENT
 MATERIAL: HAND MADE GLASS





8,
DROP

PROJEKTANT: MARIA RYPUJA
 KRAJ PRODUKCJI: POLSKA
 TYP ZAWIESI: A.5
 BRZDNEK: GP
 ŻARÓWKA NIE DOŁĄCZONA
 PRZEWÓD: PCV - PRZEJRYSTY
 MATERIAŁ: RĘCZNIE WYKAZANE SZKŁO

DESIGNER: MARIA RYPUJA
 COUNTRY OF ORIGIN: POLAND
 SLING TYPE: A.5
 SOCKET: GP
 BULB NOT INCLUDED
 CORD: PCV - TRANSPARENT
 MATERIAL: HAND MADE GLASS



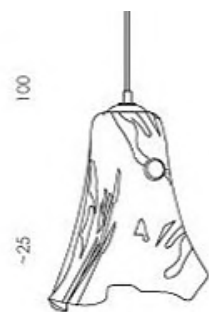

100

~25

-26

LGH0572

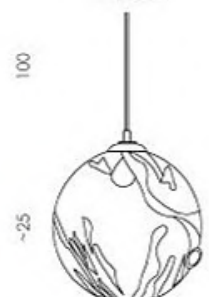

100

~25

25

LGH0570

PROJEKTANT: MARIA RYPUŁA
KRAJ PRODUKCJI: POLSKA
TYP ŻAWEŚKI: C.2
BŁONNIK: E27
ŻARÓWKA NIE DOŁĄCZONA
PRZEWÓD: TEKSTYLNÝ - SZARY
MATERIAŁ: RĘCZNIE WYTWARZANE SZKŁO

DESIGNER: MARIA RYPUŁA
COUNTRY OF ORIGIN: POLAND
LUNG TYPE: C.2
SOCKET: E27
BULB NOT INCLUDED
CORD: TEXTILE - GREY
MATERIAL: HAND MADE GLASS

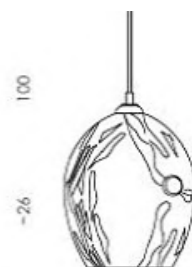

100

~26

-22

LGH0574



100

~20

-20

LGH0571



100

~40

15

LGH0573





LGH0241



LGH0240



LGH0246

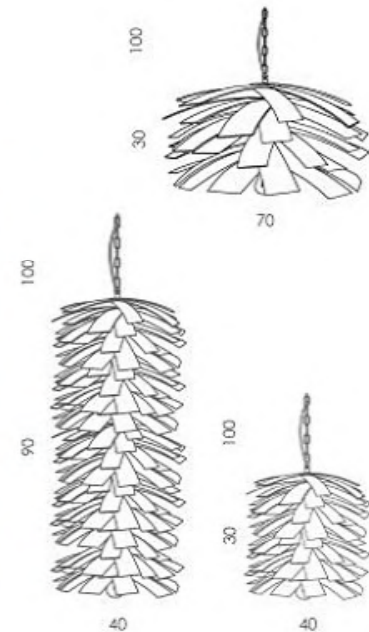

PROJEKTANT: MARIA RYPULA
 JACEK RYPULA
 KRAJ PRODUKCJI: POLSKA
 TYP ZAWIESIA: B, I
 TRZEMIEC: E27
 ŻARÓWKI NIE DOŁĄCZONA
 PRZEWÓD: PCV - 2x0,5T
 MATERIAŁ: DREWNO

DESIGNER: MARIA RYPULA
 JACEK RYPULA
 COUNTRY OF ORIGIN: POLAND
 SING TYPE: B, I
 SOCKET: E27
 BULB NOT INCLUDED
 CORD: PCV - GOLD
 MATERIAL: WOOD

_70

AVOCADO



LGH0662



LGH0661



LGH0660

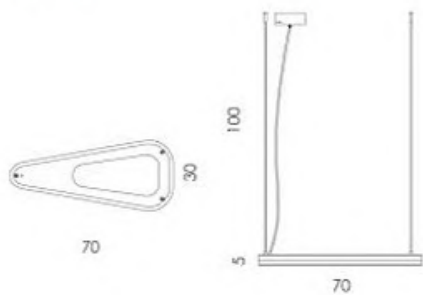

PROJEKTANT: JACEK RYPIŃA
DARIA STANCIK
KEA J PROJEKCJE POLSKA
TYP ZAWIESKI: C.3
LED
PRZEWÓD: PCV - PRZEJRYSTY
MATERIAŁ: DĄB, RÓDZAWY METAL

DESIGNER: JACEK RYPIŃA
DARIA STANCIK
COUNTRY OF ORIGIN: POLAND
SUNG TYPE: C.3
LED
CORD: PCV - TRANSPARENT
MATERIAL: OAK, RUSTY METAL



_71



LGH0650



LGH0651



LGH0652

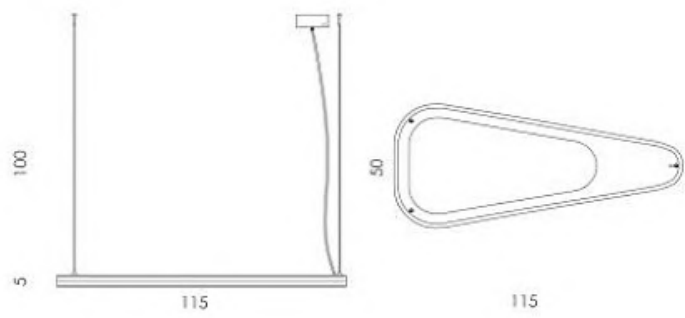

PROJEKTANT: JACEK RYPUŁA
 DARIA STANCIK
 KRAJ PRODUKCJI: POLSKA
 TYP ZAWIESIA: C.3
 LEJ
 PRZEWOÓ: PCV - TRANSPARENTNY
 MATERIAŁ: DĄB, RDZAWY METAL

DESIGNER: JACEK RYPUŁA
 DARIA STANCIK
 COUNTRY OF ORIGIN: POLAND
 SLING TYPE: C.3
 LED
 CORD: PCV - TRANSPARENT
 MATERIAL: OAK, RUSTY METAL

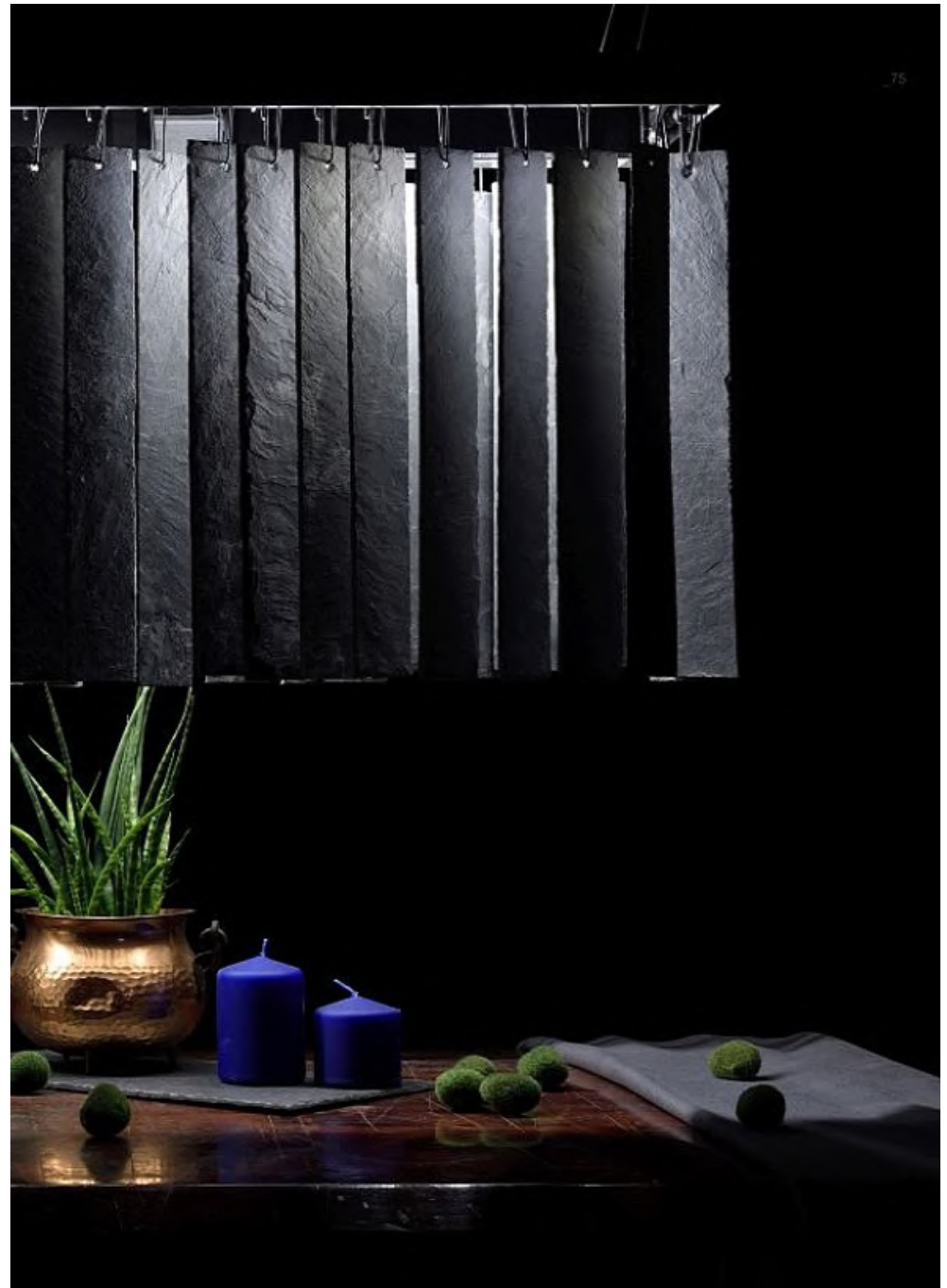

LGH0604



LGH0603



LGH0602

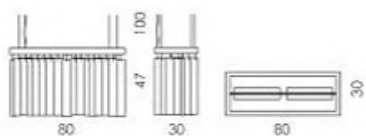
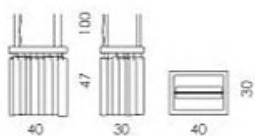
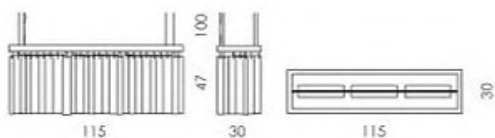

PROJEKTANT: MARIA RYPUŁA
KRAJ PRODUKCJI: POLSKA
TYP ZAWIESKI: K.1
SZCZEGÓL: 15x09, 18x09, 5x09
ŻARÓWKI NE DOLĄCZONA
PRZEWÓD: PCV - PRZEJRZYSTY
MATERIAŁ: KUPIEK

DESIGNER: MARIA RYPUŁA
COUNTRY OF ORIGIN: POLAND
SLING TYPE: K.1
SOCKET: 15x09, 18x09, 5x09
BULBS NOT INCLUDED
CORD: PCV - TRANSPARENT
MATERIAL: SLATE STONE

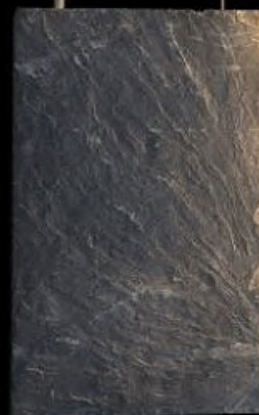

LGH0600



LGH0601

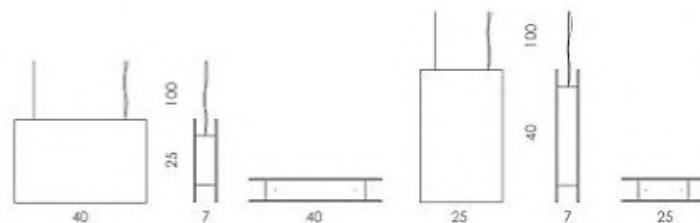

PROJEKTANT: MARIA RYPUŁA
KRAJ PRODUKCJI: POLSKA
TYP ZAWIESKI: K.1
TRZONKÓL: 6x09
ŻARÓWKI NE DOLĄCZONA
PRZEWÓD: PCV - PRZEJRZYSTY
MATERIAŁ: LUPEK

DESIGNER: MARIA RYPUŁA
COUNTRY OF ORIGIN: POLAND
SLING TYPE: K.1
SOCKET: 6x09
BULBS NOT INCLUDED
CORD: PCV - TRANSPARENT
MATERIAL: SLATE STONE



LGH0503



LGH0502

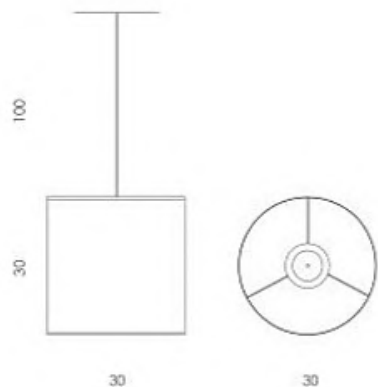

PROJEKTANT: MARIA RYPULA
 KRAJ PRODUKCJI: POLSKA
 TYP ŻARÓWKI: C.Z. C.4
 SEZONEK: E27
 ŻARÓWKI NIE DOKŁĄCZONA
 PRZEWÓD: TEKSTYLNÝ - BIAŁY, SZARY
 MATERIAŁ: TWANNA

DESIGNER: MARIA RYPULA
 COUNTRY OF ORIGIN: POLAND
 SUNG TYPE: C.Z. C.4
 SOCKET: E27
 BULBS NOT INCLUDED
 CORD: TEXTILE - WHITE, GREY
 MATERIAL: TEXTILE





LGH0501



LGH0500

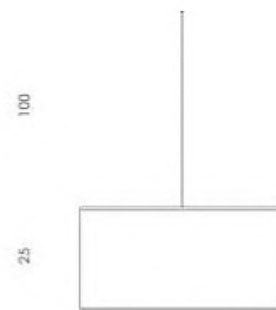

50

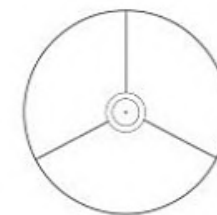

50

PROJEKTANT: MARIA RYPLA
 KRAJ PRODUKCJI: POLSKA
 TYP ZAWIESIA: C.2, C.4
 WZROWEK: E27
 ŻARÓWKA: NIE DOŁĄCZONA
 PRZEWOD: TEKSTYLNÝ - BIAŁY, SZARY
 MATERIAŁ: TKAŃNA

DESIGNER: MARIA RYPLA
 COUNTRY OF ORIGIN: POLAND
 SILING TYPE: C.2, C.4
 SOCKET: E27
 BULB NOT INCLUDED
 CORD: TEXTILE - WHITE, GREY
 MATERIAL: TEXTILE



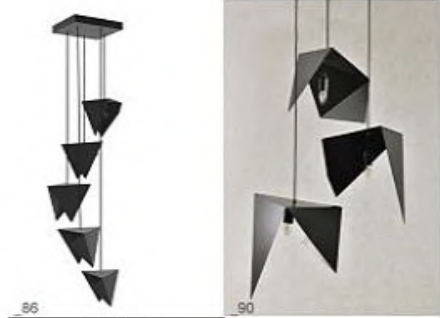



LGH0781



LGH0791

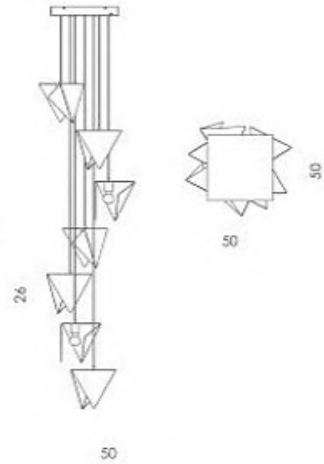

PROJEKTANT: JACEK RYPUJA
MOCNIA PŁYTA
KRAJ PRODUKCJI: POLSKA
TYP ŻARÓWKI: F.3, F.4
WZÓRNIK: 7x27
ŻARÓWKA NIE DOŁĄCZONA
PRZEWÓD: OPŁOŚ - CZARNY, BIAŁY
MATERIAŁ: METAL

DESIGNER: JACEK RYPUJA
MOCNIA PŁYTA
COUNTRY OF ORIGIN: POLAND
SUNG TYPE: F.3, F.4
SOCKET: 7x27
BULB NOT INCLUDED
CORD: TEXTILE - BLACK, WHITE
MATERIAL: METAL





LGH0790

LGH0780

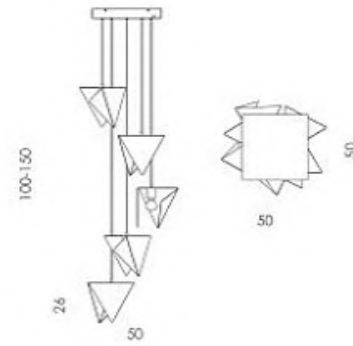

PROJEKTANT: JACZEK RYPUŁA
 MONIKA FLUTA
 KRAJ PRODUKCJI: POLSKA
 TYP ZAWIESIENIA: F
 TRZĄSANEK: E27
 ŻARÓWKI NIE DOŁĄCZONA
 PRZEWÓD: OPLIOT - CZARNY, BIAŁY
 MATERIAŁ: METAL

DESIGNER: JACZEK RYPUŁA
 MONIKA FLUTA
 COUNTRY OF ORIGIN: POLAND
 HUNG TYPE: F
 SOCKET: E27
 BULB NOT INCLUDED
 CORD: TEXTILE - BLACK, WHITE
 MATERIAL: METAL



LGH0730

LGH0740

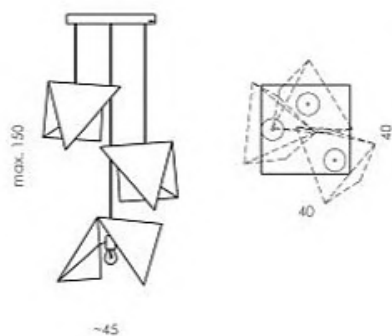

PROJEKTANT: JACEK RYPUŁA
 KRAJ PRODUKCJI: POLSKA
 TYP ŻARÓWKI: F.1, F.2
 SOCKET: 3627
 ŻARÓWKA NIĘ DORĄCZONA
 PRZEWÓD: TEKSTYLNÝ - CZARNY, ZEBRA
 MATERIAŁ: METAL

DESIGNER: JACEK RYPUŁA
 COUNTRY OF ORIGIN: POLAND
 SUNG TYPE: F.1, F.2
 SOCKET: 3627
 BULB IS NOT INCLUDED
 CORD: TEXTILE - BLACK, ZEBRA
 MATERIAL: METAL





LGH0741



LGH0731

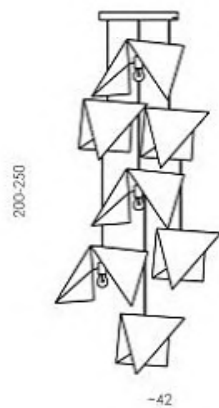

200-250

-42

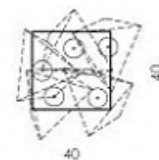

40

40

PROJEKTANT: JACEK RYPUŁA
 DARIA STANCIK
 KRAJ PRODUKCJI: POLSKA
 TYP ZAWIESI: F.3, F.4
 TRZEMIE: 7xE27
 ŻARÓWKI NIE DOŁĄCZONA
 PRZEWÓD: OPLOT - CZARNY, ŻEBRA
 MATERIAŁ: METAL

DESIGNER: JACEK RYPUŁA
 DARIA STANCIK
 COUNTRY OF ORIGIN: POLAND
 HUNG TYPE: F.3, F.4
 SOCKET: 7xE27
 BULBS NOT INCLUDED
 CORD: TEXTILE - BLACK, ZEBRA
 MATERIAL: METAL



LGH0680

LGH0681

LGH0680



LGH0681

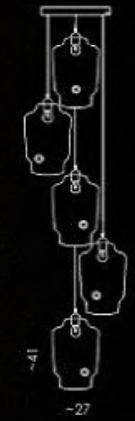

PROJEKTANT: MARIA RYPUŁA
 JACZE RYPUŁA
 ERA | PRODUKCJA POLSKA
 TYP ZAWIĘSZA: H.1, H.2
 TRZONEK: 3xE27, 5xE27
 ŻARÓWKI: NIE DOŁĄCZONA
 PRZEWOD: PCV - PRZEJRYSTY
 MATERIAŁ: RĘCZNIE WYTWARZANE SZKŁO

DESIGNER: MARIA RYPUŁA
 JACZE RYPUŁA
 COUNTRY OF ORIGIN: POLAND
 HUNG TYPE: H.1, H.2
 SOCKET: 3xE27, 5xE27
 BULBS NOT INCLUDED
 CORD: PCV - TRANSPARENT
 MATERIAL: HAND MADE GLASS



LGH0703

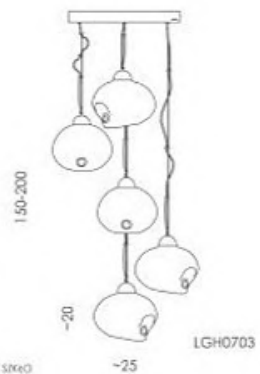

LGH0703

PROJEKTANT: JACEK RYPULA
 KRAJ PRODUKCJI: POLSKA
 TYP ZAKRESA: H.1, H.2
 ROZMIER: 5x27, 3x27
 ŻARÓWKI NIE DOŁĄCZONA
 PRZEWÓD: PCV - PRZEJRZYSTY
 MATERIAŁ: RĘCZNIE WYTWARZANE SZKŁO

DESIGNER: JACEK RYPULA
 COUNTRY OF ORIGIN: POLAND
 SENG TYPE: H.1, H.2
 SOCKET: 5x27, 3x27
 BULBS NOT INCLUDED
 CORD: PCV - TRANSPARENT
 MATERIAL: HAND-MADE GLASS

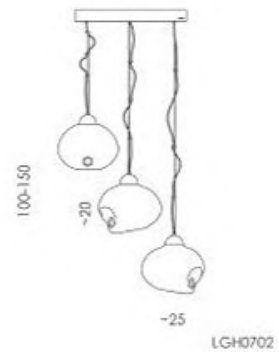

LGH0702



LGH0702

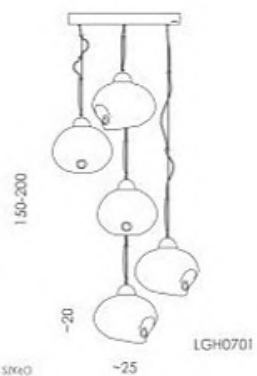

PROJEKTANT: JACEK RYPUŁA
 KRAJ PRODUKCJI: POLSKA
 TYP ZAKRESA: H.1, H.2
 SERIOWE: 5x27, 3x27
 ŻARÓWKI: NIEM. DOŁĄCZONA
 PRZEWÓD: PCV - PRZEJRZYSTY
 MATERIAŁ: RĘCZNIE WYTWARZANE SZKŁO

DESIGNER: JACEK RYPUŁA
 COUNTRY OF ORIGIN: POLAND
 SENG TYPE: H.1, H.2
 SOCKET: 5x27, 3x27
 BULBS NOT INCLUDED
 CORD: PCV - TRANSPARENT
 MATERIAL: HAND-MADE GLASS

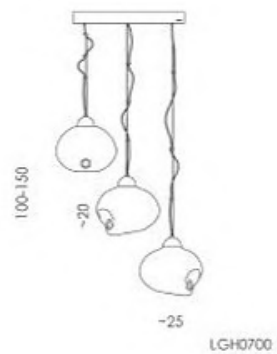

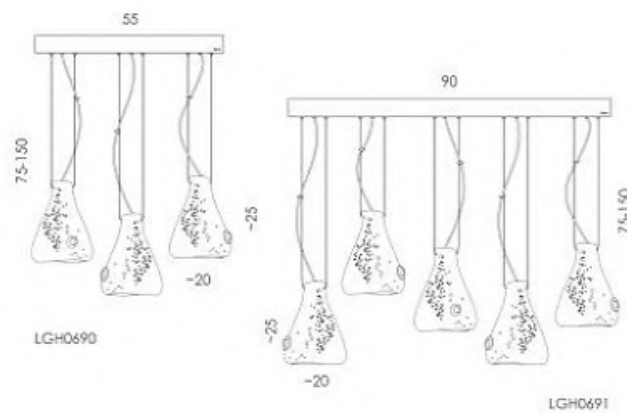

PROJEKTANT: JACEK RYPULA
 KRAJ PRODUKCJI: POLSKA
 TIP ZAWIESZA: J1, J2
 BRZOSNEK: GR
 ŻARÓWKA NIE DOŁĄCZONA
 PRZEWÓD: PCV - PRZEJRYSTY
 MATERIAŁ: RĘCZNIE WYTWARZANE SZKŁO

DESIGNER: JACEK RYPULA
 COUNTRY OF ORIGIN: POLAND
 SHED TYPE: J1, J2
 SOCKET: GR (BASE NOT INCLUDED)
 CORD: PCV - TRANSPARENT
 MATERIAL: HAND MADE GLASS



LGH0673



LGH0674



PROJEKTANT: JACEK RYPUŁA
 KRAJ PRODUKCJI: POLSKA
 TYP ZAKRESIA: L1
 SEZONEK: JWG9
 ŻARÓWKI NIE DOŁĄCZONE
 MATERIAŁ: RECZNE WYTWARZANE SZKŁO

DESIGNER: JACEK RYPUŁA
 COUNTRY OF ORIGIN: POLAND
 SLING TYPE: L1
 SOCKET: JWG9
 BULBS NOT INCLUDED
 MATERIAL: HAND-MADE GLASS





LGH0720

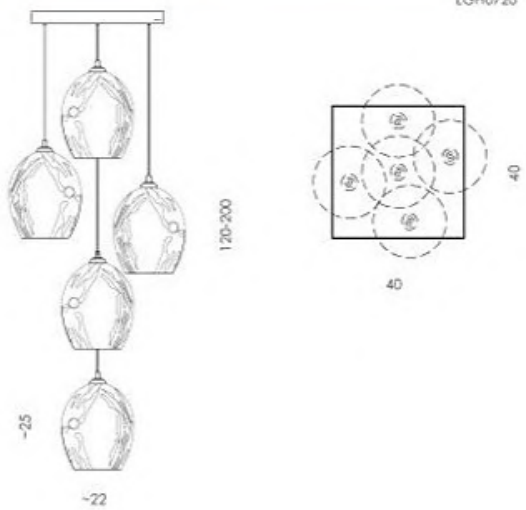

LGH0719

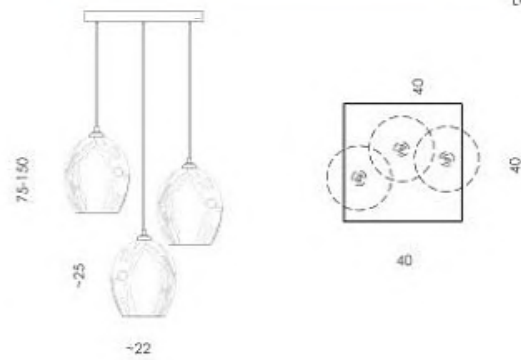

PROJEKTANT: MARIA RYPUŁA
 KRAJ PRODUKCJI: POLSKA
 TYP ŻARWIŚKI: G-2, G-3
 TRZONKĘ: 3x E27, 3x E27
 ŻARWIŃKA NIE DOŁĄCZONA
 PRZEWÓD: PCV - SZARY
 MATERIAŁ: RĘCZNIE WYTRZASKANE SZKŁO

DESIGNER: MARIA RYPUŁA
 COUNTRY OF ORIGIN: POLAND
 LAMP TYPE: G-2, G-3
 SOCKET: 3x E27, 3x E27
 BALL NOT INCLUDED
 CORD: PCV - GREY
 MATERIAL: HAND MADE GLASS

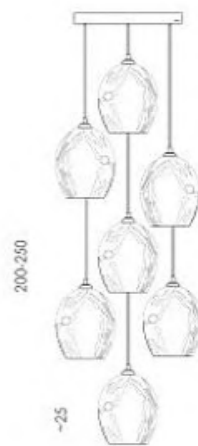

LGHD721

PROJEKTANT: MARIA RYPUŁA
 KRAJ PRODUKCJI: POLSKA
 TYPIŁ ZAWIESIENIA: G.1
 BRZONKOWANIE: 7xE27
 ŻARÓWKI I NE DOKŁĄCZENIE
 PRZEWOD: PCV - SZARY
 MATERIAŁ: RĘCZNIE WYTRZASKANE SZKŁO

DESIGNER: MARIA RYPUŁA
 COUNTRY OF ORIGIN: POLAND
 SLING TYPE: G.1
 SOCKET: 7x E27
 BULBS NOT INCLUDED
 CORD: PCV - GREY
 MATERIAL: HAND MADE GLASS



LGH0717

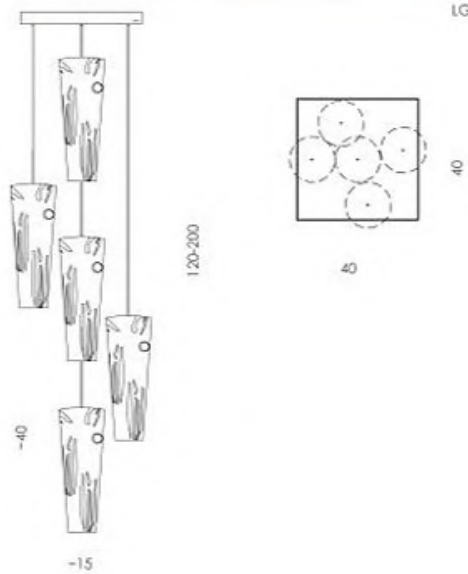

LGH0716

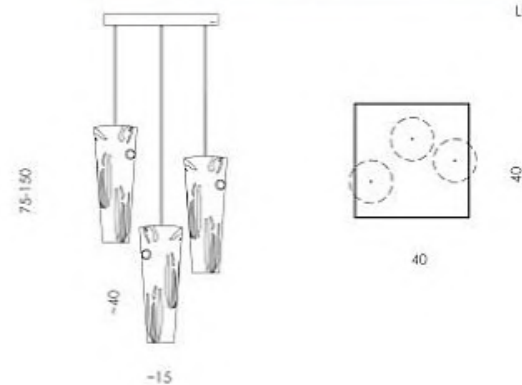

PROJEKTANT: MARIA RYPUŁA
 KRAJ PRODUKCJI: POLSKA
 TYP ZAWIESKA: G.2, G.3
 TRZCIENIE: 5x27, 3x27
 ŻARÓWKI: NIE DOŁĄCZONA
 PRZEWÓD: PCV - SZARY
 MATERIAŁ: RĘCZNIE WYTWARZANE SZKŁO

DESIGNER: MARIA RYPUŁA
 COUNTRY OF ORIGIN: POLAND
 HUNG TYPE: G.2, G.3
 SOCKET: 5x27, 3x27
 BULB NOT INCLUDED
 CORD: PCV - GREY
 MATERIAL: HAND MADE GLASS



LGH0718

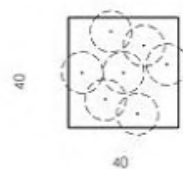

LGH0718

PROJEKTANT: MARIA RYPULA
 KRAJ PRODUKCJI: POLSKA
 TYP ŻAWIĘSIA: C.1
 WZÓRNEK: 74227
 ŻARÓWKI: NIE DOKŁADZONA
 PRZEWÓD: PCV - SZARY
 MATERIAŁ: RĘCZNIE WYTWARZANE SZKŁO

DESIGNER: MARIA RYPULA
 COUNTRY OF ORIGIN: POLAND
 SLING TYPE: C.1
 SOCKET: E27
 BULB NOT INCLUDED
 CORD: PCV - GREY
 MATERIAL: HAND MADE GLASS



LGH0711

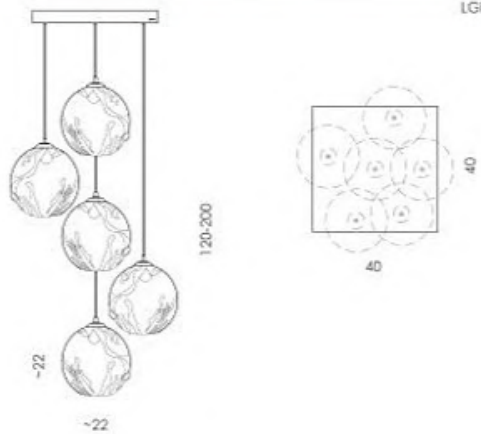

LGH0710

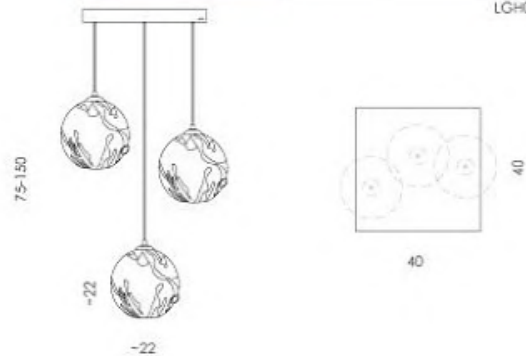

PROJEKTANT: MARIA RYPUŁA
 KRAJ PRODUKCJI: POLSKA
 TYP ZAWIESIA: G.2, G.3
 WZROŚNIE: 5x227, 3x127
 ŻARÓWKA NIE DOKŁADZONA
 PRZEWOD: PCV - SZARY
 MATERIAŁ: RĘCZNIE WYTWARZANE SZKŁO

DESIGNER: MARIA RYPUŁA
 COUNTRY OF ORIGIN: POLAND
 SLUNG TYPE: G.2, G.3
 SOCKET: 5x227, 3x127
 BULB NOT INCLUDED
 CORD: PCV - GREY
 MATERIAL: HAND MADE GLASS



LGH0714

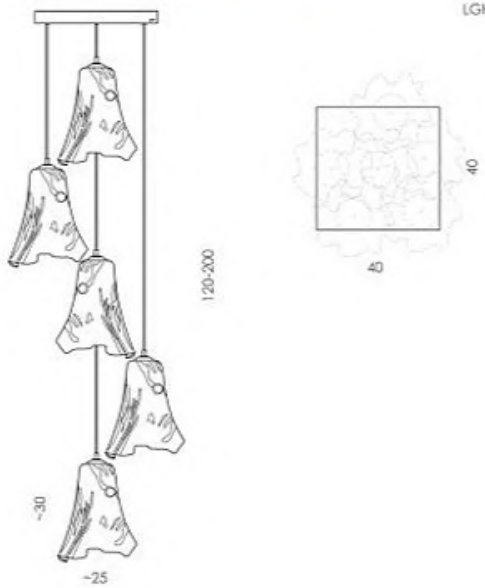

LGH0713

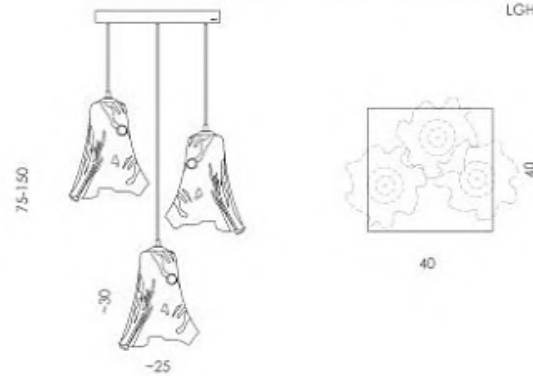

PROJEKTANT: MARIA RYPUŁA
 KRAJ PRODUKCJI: POLSKA
 TYPI ZAWIESKI: G.2, G.3
 TRZCIENIEK: 5x227, 3x227
 ŻARÓWKI: NIE DOŁĄCZONA
 PRZEWÓD: PCV - SZARY
 MATERIAŁ: RĘCZNIE WYTWARZANE SZKŁO

DESIGNER: MARIA RYPUŁA
 COUNTRY OF ORIGIN: POLAND
 HUNG TYPE: G.2, G.3
 SOCKET: 5x227, 3x227
 BULB NOT INCLUDED
 CORD: PCV - GREY
 MATERIAL: HAND MADE GLASS



LGH0715

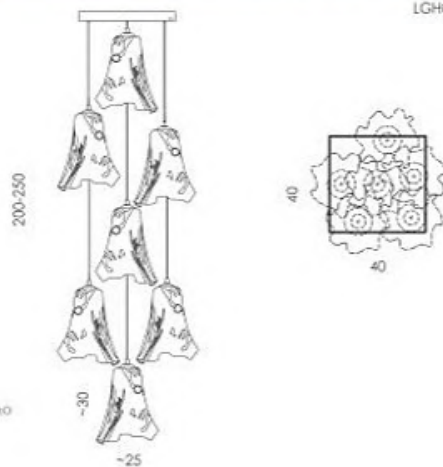

PROJEKTANT: MARIA RYPUŁA
 KRAJ PRODUKCJI: POLSKA
 TYPIE ŻARWIŚKI: G.1
 ŚCIEŁOŚĆ: 7x27
 ŻARWIŚKA NIE DOŁĄCZONA
 PRZEWOÓD: PCV - SZARY
 MATERIAŁ: RĘCZNE WYTWARZANE SIKKO

DESIGNER: MARIA RYPUŁA
 COUNTRY OF ORIGIN: POLAND
 SLING TYPE: G.1
 SOCKET: 7x27
 BULB NOT INCLUDED
 CORD: PCV - GREY
 MATERIAL: HAND MADE GLASS







LGH0861



LGH0862



30



40



85



80

PROJEKTANT: MARIA RYPUŁA
 JACEK RYPUŁA
 ERA | PRODUKCJA POLSKA
 TYP ZAWIESIA: L1, L2
 TRZONEK: 11x09, 12x09
 ŻARÓWKI NIE DOŁĄCZONA
 PRZEWÓD: SWIATŁOWOD W OPŁOCCIE
 MATERIAŁ: KRYSZTAŁ GÓRSKI

DESIGNER: MARIA RYPUŁA
 JACEK RYPUŁA
 COUNTRY OF ORIGIN: POLAND
 SLING TYPE: L1, L2
 SOCKET: 11x09, 12x09
 BULB(S) NOT INCLUDED
 CORD, BRACKET PIER
 MATERIAL: MOUNTAIN CRYSTAL



LGH0863

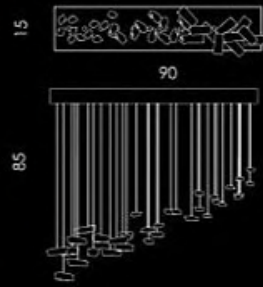

LGH0864

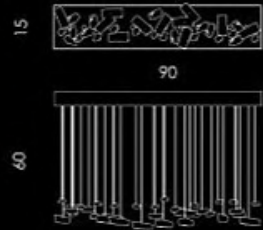

LGH0865

PROJEKTANT: MARIA RYPUŁA
 JACEK RYPUŁA
 KRAJ PRODUKCJI: POLSKA
 TYP ŻARWIŚKI: M.1
 TECHNIKA: 12W/0
 ŻARWIŃKA NIE DOŁĄCZONA
 PRZEWÓD: ŚWIATŁOWÓD W OPŁOCIE
 MATERIAŁ: KRYSZTAŁ GÓRSKI

DESIGNER: MARIA RYPUŁA
 JACEK RYPUŁA
 COUNTRY OF ORIGIN: POLAND
 LAMP TYPE: M.1
 SOCKET: 12W/0
 BULB NOT INCLUDED
 CORD: BEADED FIBER
 MATERIAL: MOUNTAIN CRYSTAL





LGH0866

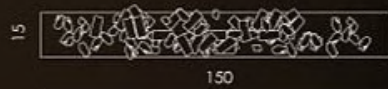

PROJEKTANT: MARIA RYPULA
 JACEK RYPULA
 KRAJ PRODUKCJI: POLSKA
 TYP ŻARWIŁKA: M.1
 TRZONKIEC: 12xG9
 ŻARWIŁKA NIE DOŁĄCZONA
 PRZEZWOD: SWIATŁOWOD W OPŁOCIE
 MATERIAŁ: KRYSZTAŁ GÓRSKI

DESIGNER: MARIA RYPULA
 JACEK RYPULA
 COUNTRY OF ORIGIN: POLAND
 SLING TYPE: M.1
 SOCKET: 12xG9
 BULB NOT INCLUDED
 CORD: BRAIDED FIBER
 MATERIAL: MOUNTAIN CRYSTAL



LGH0867



PROJEKTANT: MARIA RYPULA
 JACEK RYPULA
 KRAJ PRODUKCJI: POLSKA
 TYP ŻARWIŁKA: M.1
 TRZONKIEC: 12xG9
 ŻARWIŁKA NIE DOŁĄCZONA
 PRZEZWOD: SWIATŁOWOD W OPŁOCIE
 MATERIAŁ: KRYSZTAŁ GÓRSKI

DESIGNER: MARIA RYPULA
 JACEK RYPULA
 COUNTRY OF ORIGIN: POLAND
 SLING TYPE: M.1
 SOCKET: 12xG9
 BULB NOT INCLUDED
 CORD: BRAIDED FIBER
 MATERIAL: MOUNTAIN CRYSTAL





_130



_132



_134



LGH0244



LGH0245

PROJEKTANT: MARIA RYPULA
 JACEK RYPULA
 KRAJ PRODUKCJI: POLSKA
 WZROUNEK: E27
 ŻARÓWKI NIE DOŁĄCZONA
 PRZEWOÓD: TEKSTYLNÝ - CZARNY
 MATERIAŁ: DREWNO, METAL, NYLON

DESIGNER: MARIA RYPULA
 JACEK RYPULA
 COUNTRY OF ORIGIN: POLAND
 SOCKET: E27
 BULB NOT INCLUDED
 CORD: TEXTILE - BLACK
 MATERIAL: WOOD, METAL, COPPER



LGH0271

LGH0270

KRAJ PRODUKCJI: POLSKA
 TYP WTYCZKI: A.1
 ŻARÓWKI: E27
 ŻARÓWKI: NIEM. DOŁĄCZONA
 PRZEWÓD: TEKSTYLN. - CZARNY
 MATERIAŁ: MIEDŹ

COUNTRY OF ORIGIN: POLAND
 PLUG TYPE: A.1
 SOCKET: E27
 BULBS NOT INCLUDED
 CORD: TEXTILE - BLACK
 MATERIAL: COPPER



LGH0272

LGH0273

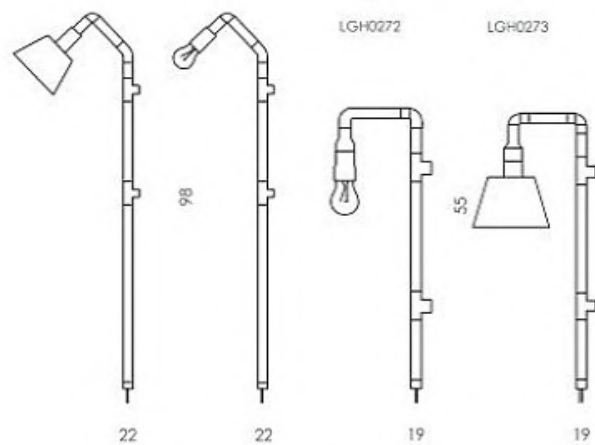

22

22

19

19

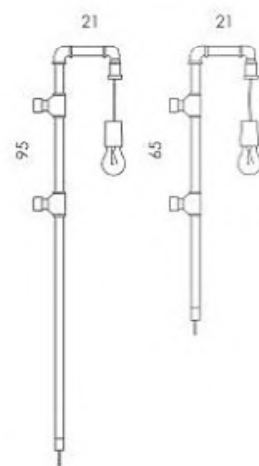

LGH0280

LGH0281

KRAJ PRODUKCJI: POLSKA
 TRZCIENIE: E27
 ŻARÓWKI: NE DOKŁĄCZONA
 TYP WTYCZKI: A.1
 PRZEWÓD: TEKSTYLNÝ - CZARNY
 MATERIAŁ: METAL

COUNTRY OF ORIGIN: POLAND
 SOCKET: E27
 BULBS NOT INCLUDED
 PLUG TYPE: A.1
 CORD: TEXTILE - BLACK
 MATERIAL: METAL

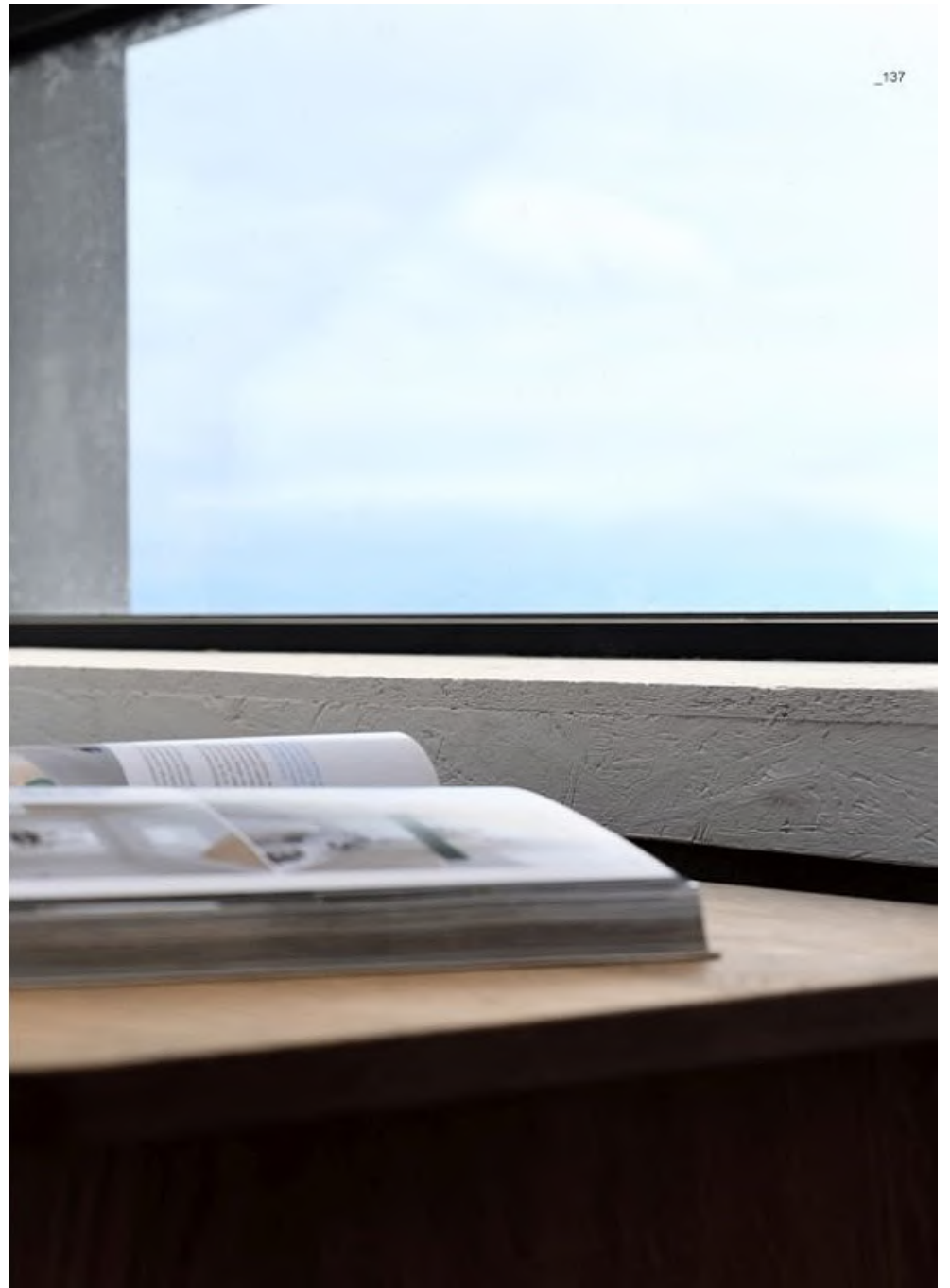

_138



_140



_142



_144



_145



_146



_150



_152



_154



_156



_158



_160

_139



LGH0080



LGH0090

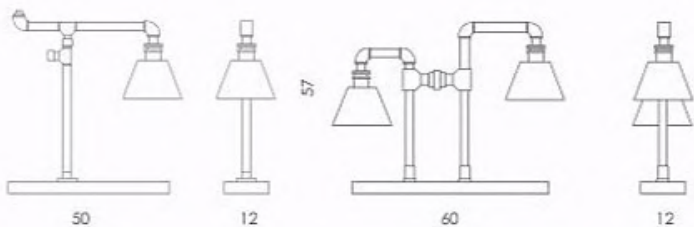

KRAJ PRODUKCJI: POLSKA
 TYP WYCIĄGU: A.1
 REZONANS: E27
 ŻARÓWKI: NIE DOŁĄCZONA
 PRZEWÓD: TEKSTYLNÝ - CZARNY
 MATERIAŁ: METAL, DĄB

COUNTRY OF ORIGIN: POLAND
 PLUG TYPE: A.1
 SOCKET: E27
 BULBS NOT INCLUDED
 CORD: TEXTILE - BLACK
 MATERIAL: METAL, OAK





LGH0030



LGH0040



32

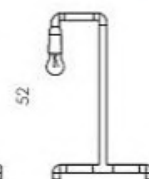

52

25



50



60

12

PROJEKTANT: JACEK RYPULA
KRAJ PRODUKCJI: POLSKA
TYP WTYCZKI: A 3
WZÓRNEK: L27
ŻARÓWKA NIE DOŁĄCZONA
PRZEWÓD: TEKSTYLNÝ - ZŁOTO
MATERIAŁ: MIEDŹ

DESIGNER: JACEK RYPULA
COUNTRY OF ORIGIN: POLAND
PLUG TYPE: A 3
SOCKET: E27
BULB NOT INCLUDED
CORD: TEXTILE - GOLD
MATERIAL: COPPER

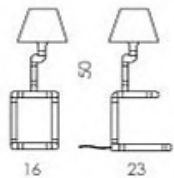

PROJEKTANT: JACEK RYPULA
 KRAJ PRODUKCJI: POLSKA
 TYP WTYCZKI: A-2
 TYCZONKĘ: E14
 ŻARÓWKI NIE DOKŁĄCZONA
 PRZEWÓD: TEKSTYLNÝ - ZEBRA
 MATERIAŁ: MIEDŹ

DESIGNER: JACEK RYPULA
 COUNTRY OF ORIGIN: POLAND
 PLUG TYPE: A-2
 SOCKET: E14
 BULB NOT INCLUDED
 CORD: TEXTILE - ZEBRA
 MATERIAL: COPPER



LGH0220

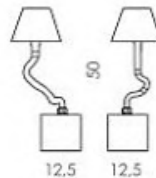
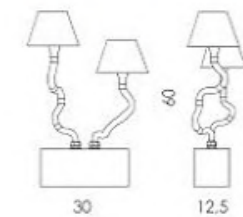

LGH0211

PROJEKTANT: JACEK RYPULA
 KRAJ PRODUKCJI: POLSKA
 TYP WTYCZKI: A-2
 TYCZONKĘ: E14
 ŻARÓWKI NIE DOKŁĄCZONA
 PRZEWÓD: TEKSTYLNÝ - ZEBRA
 MATERIAŁ: MIEDŹ, DREWNO

DESIGNER: JACEK RYPULA
 COUNTRY OF ORIGIN: POLAND
 PLUG TYPE: A-2
 SOCKET: E14
 BULB NOT INCLUDED
 CORD: TEXTILE - ZEBRA
 MATERIAL: COPPER, WOOD



LGH0611



LGH0615



LGH0617



LGH0613

PROJEKTANT: JACEK RYPUŁA
KRAJ PRODUKCJI: POLSKA
TYP WTYCZKI: A. I
SEZON: OS
ŻARÓWKA NIE DOLĄCZONA
PRZEWÓD: TEKSTYLNÝ - CZARNÝ
MATERIAŁ: RĘCZNE WYTWARZANE SZKŁO, DĄB

DESIGNER: JACEK RYPUŁA
COUNTRY OF ORIGIN: POLAND
PLUG TYPE: A. I
SOCKET: G9
BULB NOT INCLUDED
CORD: TEXTILE - BLACK
MATERIAL: HAND MADE GLASS, OAK



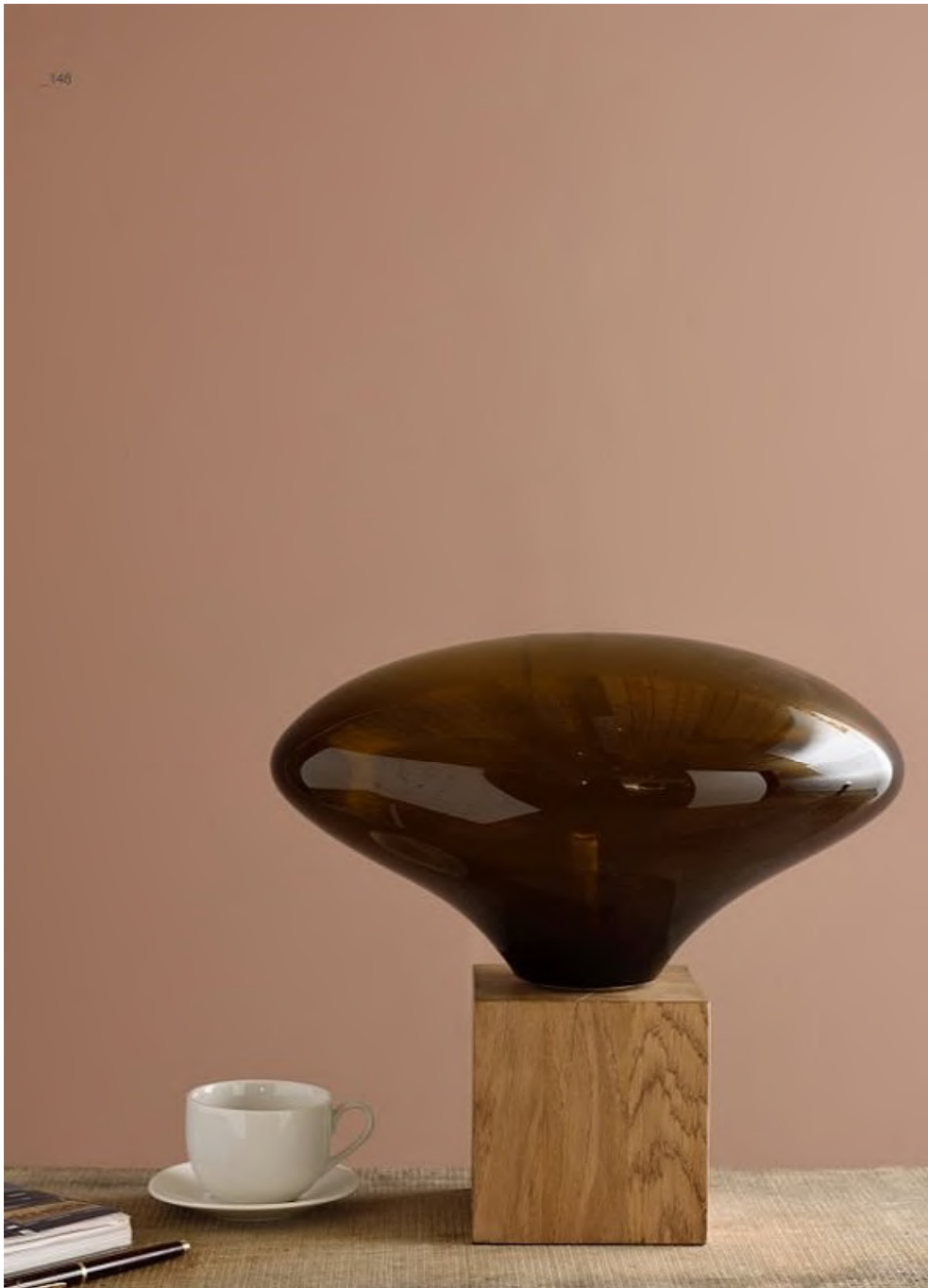

LGH0610



LGH0614



LGH0616



LGH0612

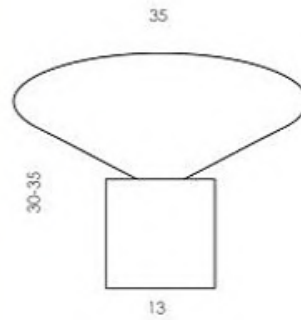

PROJEKTANT: JACEK RYPIŃA
 KRAJ PRODUKCJI: POLSKA
 TYP WTYCZKI: A, I
 IRYZONEX: GP
 ŻARÓWKA NIE DOŁĄCZONA
 PRZEWÓD: TEKSTYLNY - CZARNY
 MATERIAŁ: RĘCZNE WYTWARZANE SZKŁO, DĄB

DESIGNER: JACEK RYPIŃA
 COUNTRY OF ORIGIN: POLAND
 PLUG TYPE: A, I
 SOCKET: GP
 BULB NOT INCLUDED
 CORD: TEXTILE - BLACK
 MATERIAL: HAND-MADE GLASS, OAK



LGH0070



LGH0072



LGH0075



LGH0071



LGH0073



LGH0074

PROJEKTANT: MARIA RYPUŁA
KRAJ PRODUKCJI: POLSKA
TYP WTYCZKI: A.1
REGION: E27
ŻARÓWKA NIE DOŁĄCZONA
PRZEWÓD: TEKSTYLNÝ - CZARNY
MATERIAŁ: RĘCZNIE WYTWARZANE SZKŁO

DESIGNER: MARIA RYPUŁA
COUNTRY OF ORIGIN: POLAND
PLUG TYPE: A.1
SOCKET: E27
BULB NOT INCLUDED
CORD: TEXTILE - BLACK
MATERIAL: HAND MADE GLASS

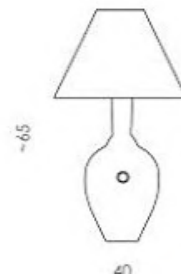



LGH0192



LGH0191



LGH0190

_153
FOG



90

40



70

31

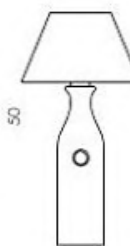

50

31

PROJEKTANT: MARIA RYPUŁA
 KRAJ PRODUKCJI: POLSKA
 TYP WTYCZKI: A.1
 WZÓRNEK: L27
 ŻARÓWKI NIE DOŁĄCZONA
 PRZEWÓD: TEKSTYLNÝ - CZARNY
 MATERIAŁ: RĘCZNIE WYTWARZANE SZKŁO

DESIGNER: MARIA RYPUŁA
 COUNTRY OF ORIGIN: POLAND
 PLUG TYPE: A.1
 SOCKET: E27
 BULB NOT INCLUDED
 CORD: TEXTILE - BLACK
 MATERIAL: HAND MADE GLASS

BASE



LGH0180



LGH0181



LGH0182



70-80

50

PROJEKTANT: MARIA RYPULA, JACEK RYPULA
KRAJ PRODUKCJI: POLSKA
TYP WTYCZKI: A.1
SEZONEK: E27
ŻARÓWKI NE DOLĄCZONA
PRZEWÓD: TEKSTYLNÝ - CZARNÝ
MATERIAŁ: RĘCZNE WYTWARZANE SZKŁO

DESIGNER: MARIA RYPULA, JACEK RYPULA
COUNTRY OF ORIGIN: POLAND
PLUG TYPE: A.1
SOCKET: E27
BULB NOT INCLUDED
CORD: TEXTILE - BLACK
MATERIAL: HAND MADE GLASS





LGH0171



LGH0170

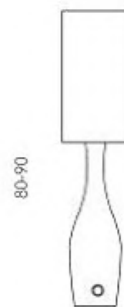

80-90

20

PROJEKTANT: MARIA RYPUŁA, JACEK RYPUŁA
 KRAJ PRODUKCJI: POLSKA
 TYP WTYCZKI: A.1
 WZROUNEK: E27
 ŻARÓWKA NIE DOKŁADZONA
 PRZEWÓD: TEKSTYLNY - CZARNY
 MATERIAŁ: RĘCZNIE WYTWARZANE SZKŁO

DESIGNER: MARIA RYPUŁA, JACEK RYPUŁA
 COUNTRY OF ORIGIN: POLAND
 PLUG TYPE: A.1
 SOCKET: E27
 BULB NOT INCLUDED
 CORD: TEXTILE - BLACK
 MATERIAL: HAND MADE GLASS



LGH0587



LGH0585



LGH0583



LGH0586



LGH0584



LGH0582

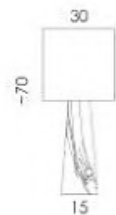
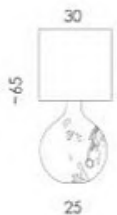
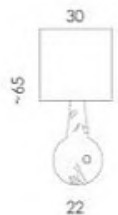

PROJEKTANT: MARJA RYPUŁA
KRAJ PRODUKCJI: POLSKA
TYP WTYCZKI: A.1
SZCZEGÓL: E27
ŻARÓWKI: NIE DOŁĄCZONA
PRZEWÓD: TEKSTYLNÝ - CZARNÝ
MATERIAŁ: RĘCZNE WYTWARZANE SZKŁO

DESIGNER: MARJA RYPUŁA
COUNTRY OF ORIGIN: POLAND
PLUG TYPE: A.1
SOCKET: E27
BULB NOT INCLUDED
CORD: TEXTILE - BLACK
MATERIAL: HAND-MADE GLASS





LGH0592



LGH0591



LGH0589



LGH0590

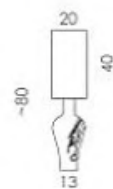

LGH0588

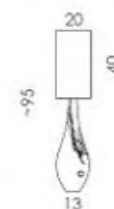

PROJEKTANT: MARIA RYPUŁA
 KRAJ PRODUKCJI: POLSKA
 TYPI WYCIŚNIĘCIA: A.1
 WZÓRNIK: D27
 ŻARÓWKI NIE DOŁĄCZONA
 PRZEWÓD: TEKSTYLNÝ - CZARNÝ
 MATERIAŁ: RĘCZNIE WYKONANE SZKŁO

DESIGNER: MARIA RYPUŁA
 COUNTRY OF ORIGIN: POLAND
 PLUG TYPE: A.1
 SOCKET: E27
 BULB NOT INCLUDED
 CORD: TEXTILE - BLACK
 MATERIAL: HAND MADE GLASS





_168



_166



_178



_172



_174



_176

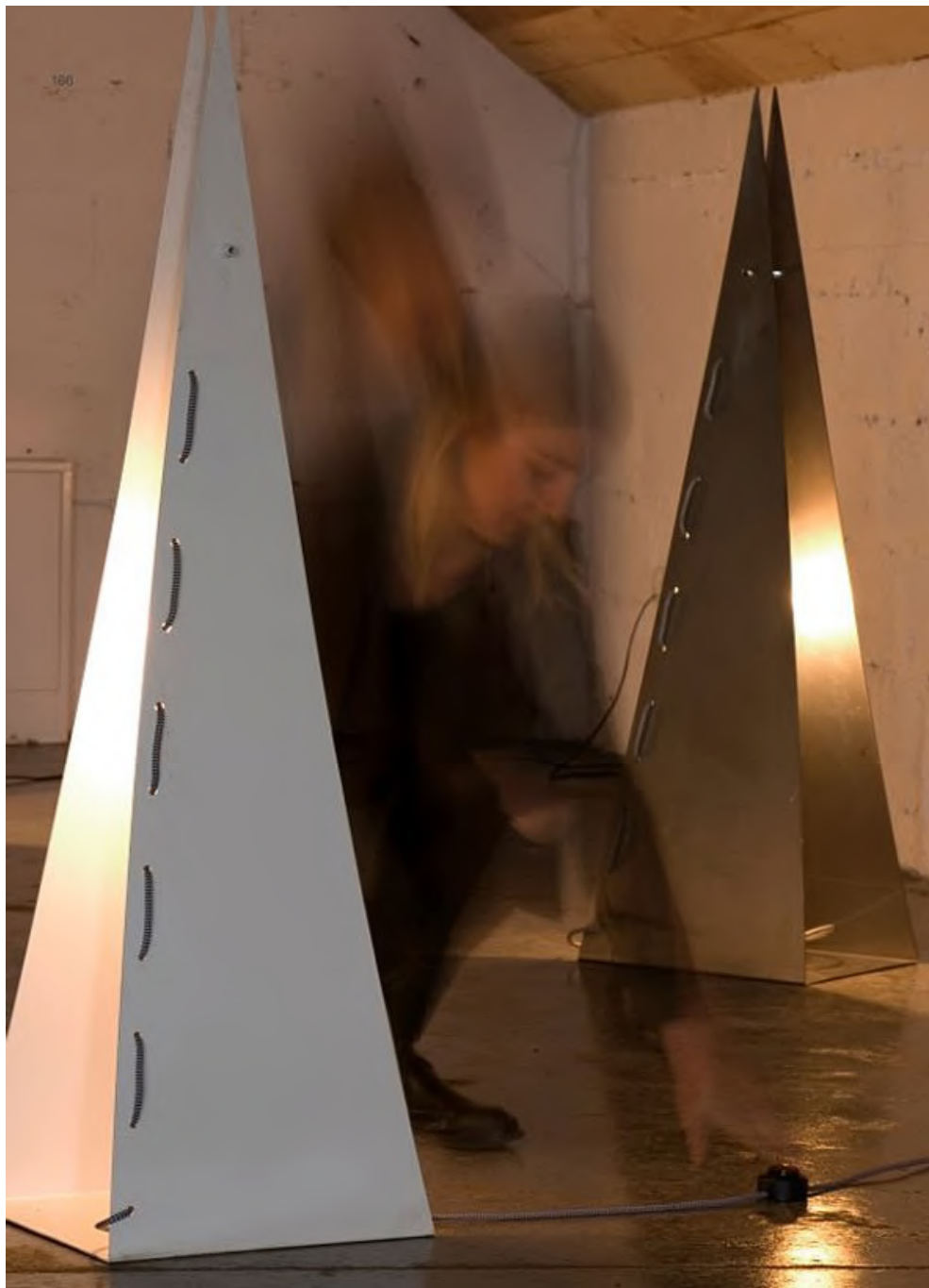

LGH0351

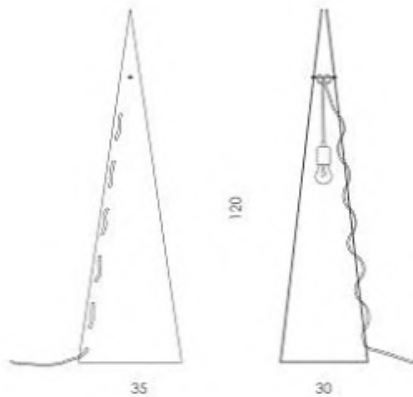

35

30

120

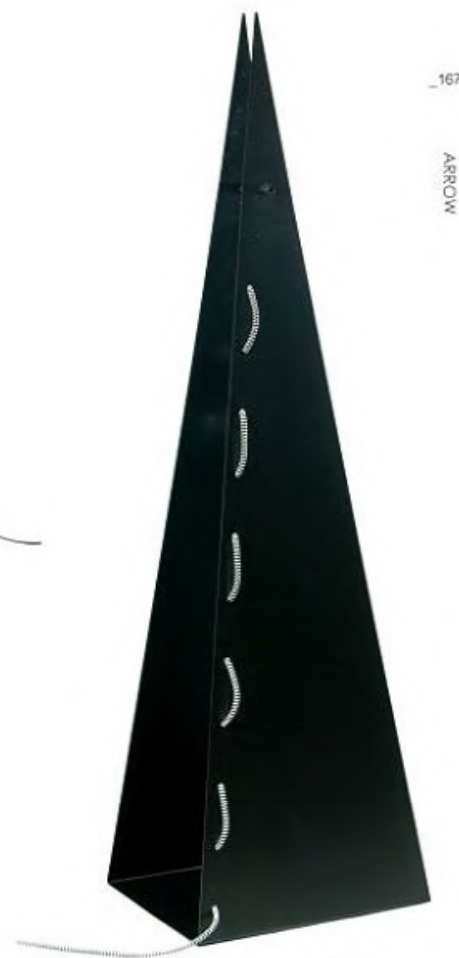

LGH0350

PROJEKTANT: JACEK RYPULA
 MAGDA KOSZYRA
 KRAJ PRODUKCJI: POLSKA
 TYP WTYCZKI: B.3
 PRZEMIENNIK: E27
 ŻARÓWKI NIE DOŁĄCZONA
 PRZEWÓD: TEKSTYLNY - ZEBRA
 MATERIAŁ: METAL

DESIGNER: JACEK RYPULA
 MAGDA KOSZYRA
 COUNTRY OF ORIGIN: POLAND
 PLUG TYPE: B.3
 SOCKET: E27
 BULB NOT INCLUDED
 CORD: TEXTILE - ZEBRA
 MATERIAL: METAL



LGH0360



LGH0361

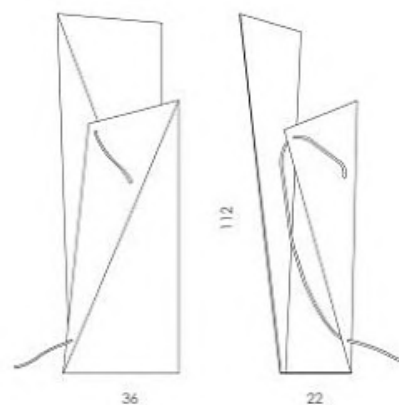

PROJEKTANT: JACEK RYPULA
 MAGDA KOSTYRA
 KRAJ PRODUKCJI: POLSKA
 TYP WTYCZKI: B.3
 PRZEMEK: E27
 ŻARÓWKI: NE DOLAČZONA
 PRZEWÓD: TEKSTYLNÝ - ZEMIA
 MATERIAŁ: METAL

DESIGNER: JACEK RYPULA
 MAGDA KOSTYRA
 COUNTRY OF ORIGIN: POLAND
 PLUG TYPE: B.3
 SOCKET: E27
 BULB NOT INCLUDED
 CORD: TEXTILE - ZEMIA
 MATERIAL: METAL



LGH0151



LGH0150



LGH0152

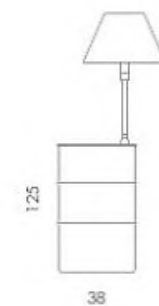

PROJEKTANT: MARIA RYPUŁA
 KRAJ PRODUKCJI: POLSKA
 TYPI WTYCZKI: B.2
 WZÓRNIK: E27
 ŻARÓWKA NIE DOKŁADZONA
 PRZEWÓD: PCV - CZARNY
 MATERIAŁ: METAL

DESIGNER: MARIA RYPUŁA
 COUNTRY OF ORIGIN: POLAND
 PLUG TYPE: B.2
 SOCKET: E27
 BULB NOT INCLUDED
 CORD: PCV - BLACK
 MATERIAL: METAL



LGH0010



LGH0020

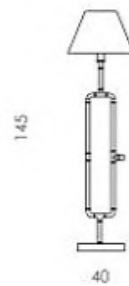

PROJEKTANT: JACEKRYPIULA
 KRAJ PRODUKCJI: POLSKA
 TYP WTYCZKI: 3.1
 WZROUNEK: E27
 ŻARÓWKA NIE DOŁĄCZONA
 PRZEWÓD: PCV - CZARNY, 360CM
 MATERIAŁ: METAL, MIEDŹ

DESIGNER: JACEKRYPIULA
 COUNTRY OF ORIGIN: POLAND
 PLUG TYPE: 3.1
 SOCKET: E27
 BULB NOT INCLUDED
 CORD: PCV - BLACK, GOLD
 MATERIAL: METAL, COPPER



LGH0031



PROJEKTANT: JACEK RYPUŁA
 KRAJ PRODUKCJI: POLSKA
 TIP WTYCZKI: S.I
 WZROŚNIEK: E27
 ŻARÓWKI NIE DOŁĄCZONA
 PRZEWÓD: PCV - ZŁOТЫ
 MATERIAŁ: MIEDŹ

DESIGNER: JACEK RYPUŁA
 COUNTRY OF ORIGIN: POLAND
 PLUG TYPE: S.I
 SOCKET: E27
 BULBS NOT INCLUDED
 CORD: PCV - GOLD
 MATERIAL: COPPER

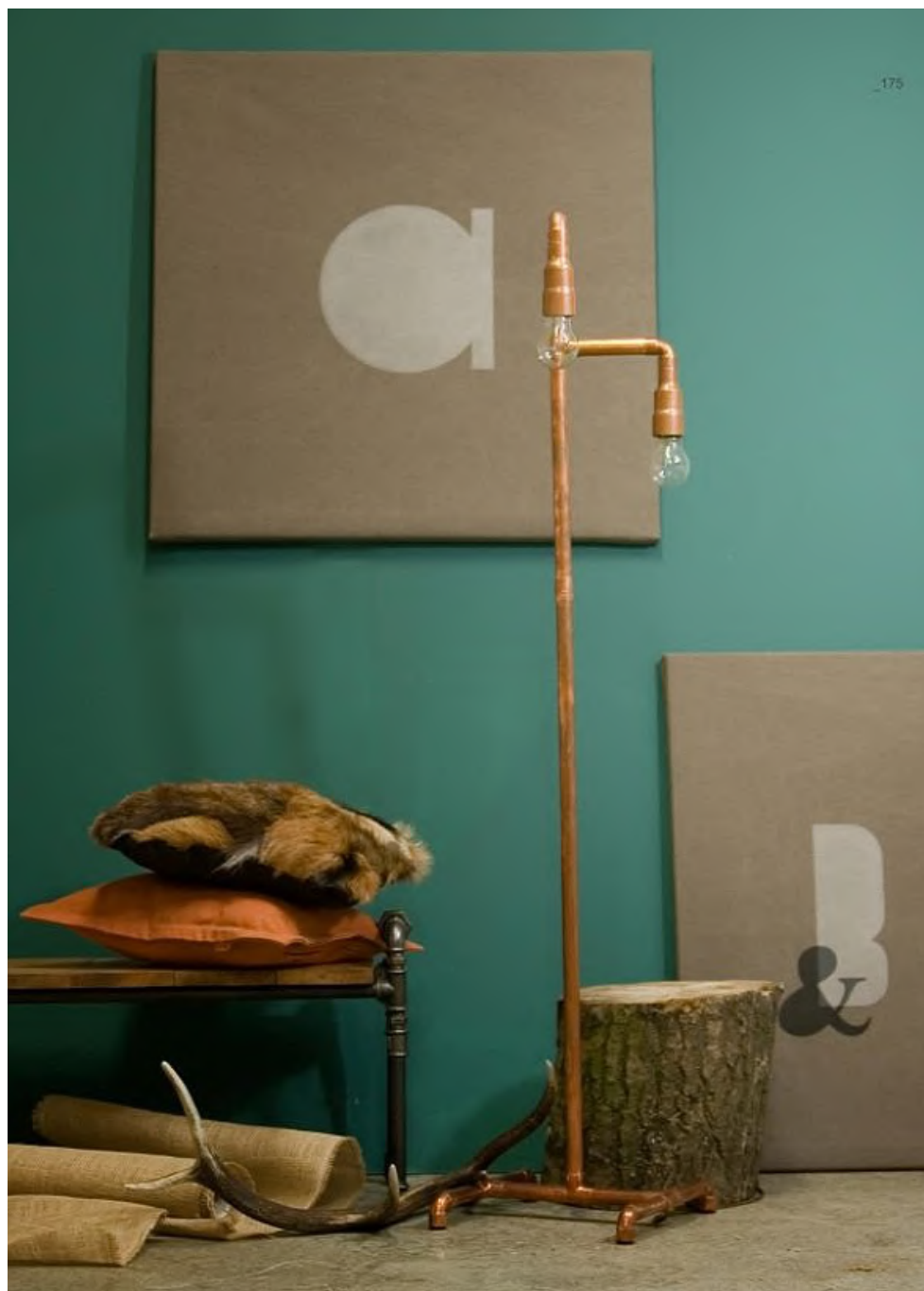

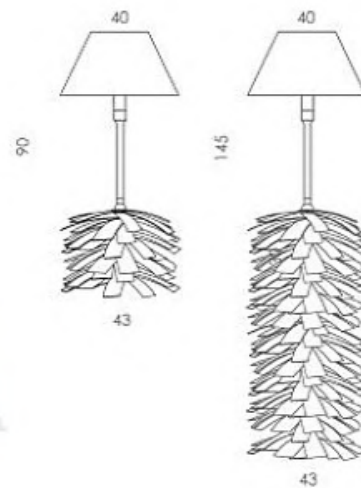

_177

SHINGLE



LGH0243



LGH0242

PROJEKTANT: MARIA RYPULA
 JACZEK RYPULA
 KRAJ PRODUKCJI: POLSKA
 TYP WYCIĘKI: B.1
 WZÓRNEK: E27
 ŻARÓWKI NIE DOŁĄCZONA
 PRZEWÓD: PCV - 2x0,75
 MATERIAŁ: DREWNO

DESIGNER: MARIA RYPULA
 JACZEK RYPULA
 COUNTRY OF ORIGIN: POLAND
 PLUG TYPE: B.1
 SOCKET: E27
 BULB NOT INCLUDED
 CORD: PCV - GOLD
 MATERIAL: WOOD



PROJEKTANT: MARIA RYPULA
 KRAJ PRODUKCJI: POLSKA
 TIP WTYCZKI: B.2
 GŁOŚNIK: E27
 ŻARÓWKI NIE DOKŁĄCZONA
 PRZEWOD: PCV - CZARNY
 MATERIAŁ: METALOWE NOGI
 TEKSTYLNĄ ABAZUR

DESIGNER: MARIA RYPULA
 COUNTRY OF ORIGIN: POLAND
 PLUG TYPE: B.2
 SOCKET: E27
 BALL NOT INCLUDED
 CORD: PCV - BLACK
 MATERIAL: METAL BASE
 TEXTILE SHADE





LGH0512



LGH0513

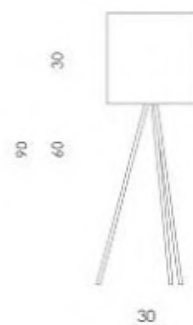

PROJEKTANT: MARIA RYPULA
 KRAJ PRODUKCJI: POLSKA
 TYP WTYCZKI: S.2
 BRZOSKIEK: E27
 ŻARÓWKA NIE DOŁĄCZONA
 PRZEWÓD: PCV - CZARNY
 MATERIAŁ: METALOWE NOGI
 TEKSTYLNĄ ABADUR

DESIGNER: MARIA RYPULA
 COUNTRY OF ORIGIN: POLAND
 PLUG TYPE: S.2
 SOCKET: E27
 BULB NOT INCLUDED
 CORE: PCV - BLACK
 MATERIAL: METAL BASE
 TEXTILE SHADE



LGH0510



LGH0511

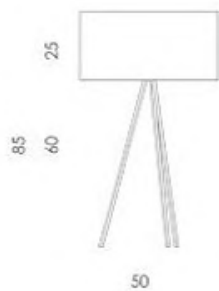

PROJEKTANT: MARIA RYPULA
KRAJ PRODUKCJI: POLSKA
TYP WTYCZKI: B.2
GŁOŃNIEK: E27
ŻARÓWKI NIE DOKŁĄCZONA
PRZEWOD: PCV - CZARNY
MATERIAŁ: METALOWE NOGI
TEKSTYLNĄ ABAZUR

DESIGNER: MARIA RYPULA
COUNTRY OF ORIGIN: POLAND
PLUG TYPE: B.2
SOCKET: E27
BULB NOT INCLUDED
CORD: PCV - BLACK
MATERIAL: METAL BASE
TEXTILE SHADE





SLING/ ZAWIESE: A.1
H55mm, 50mm, 130mm
CORD: PCV, TRANSPARENT, CEILING ROSE: METAL, RAL 7048
PRZEWÓD: PCV, PRZEJRZYSTY, PODSUFITKA: METAL, RAL 7048



SLING/ ZAWIESE: A.3
H55mm, 50mm, 130mm
CORD: TEXTILE, ZEBRA, CEILING ROSE: METAL, RAL 9003
PRZEWÓD: TEKSTYL, ZEBRRA, PODSUFITKA: METAL, RAL 9003



SLING/ ZAWIESE: A.5
H55mm, 50mm, 130mm
CORD: PCV, TRANSPARENT, CEILING ROSE: METAL, RAL 7048
PRZEWÓD: PCV, PRZEJRZYSTY, PODSUFITKA: METAL, RAL 7048



SLING/ ZAWIESE: A.2
H55mm, 50mm, 130mm
CORD: TEXTILE, BLACK, CEILING ROSE: METAL, RAL 9005
PRZEWÓD: TEKSTYL, CZARNY, PODSUFITKA: METAL, RAL 9005



SLING/ ZAWIESE: A.4
H55mm, 50mm, 130mm
CORD: PCV, TRANSPARENT, CEILING ROSE: METAL, RUSTY
PRZEWÓD: PCV, PRZEJRZYSTY, PODSUFITKA: METAL, RÓŻAWY



SLING/ ZAWIESE: B.1
H55mm, 50mm, 130mm
CORD: PCV, GOLD, CEILING ROSE: METAL, RAL 9005
PRZEWÓD: PCV, ŻŁOTY, PODSUFITKA: METAL, RAL 9005



SLING/ ZAWIEŚE: C.1
H55mm, 50mm, 130mm
CORD: PCV, TRANSPARENT, CEILING ROSE: METAL, RUSTY
PRZEWÓD: PCV, PRZEJRZYSTY, PODSUFITKA: METAL, RDZAWY



SLING/ ZAWIEŚE: C.2
H55mm, 50mm, 130mm
CORD: TEXTILE, BLACK, CEILING ROSE: METAL, RAL 9003
PRZEWÓD: TEKSTYL, CZARNY, PODSUFITKA: METAL, RAL 9003



SLING/ ZAWIEŚE: C.3
H55mm, 50mm, 130mm
CORD: PCV, TRANSPARENT, CEILING ROSE: METAL, RAL 7048
PRZEWÓD: PCV, PRZEJRZYSTY, PODSUFITKA: METAL, RAL 7048



SLING/ ZAWIEŚE: C.4
H55mm, 50mm, 130mm
CORD: PCV, TRANSPARENT, CEILING ROSE: METAL, RAL 9003
PRZEWÓD: PCV, PRZEJRZYSTY, PODSUFITKA: METAL, RAL 9003



SLING/ ZAWIEŚE: C.5
H55mm, 50mm, 130mm
CORD: TEXTILE, BLACK, CEILING ROSE: METAL, RAL 9005
PRZEWÓD: TEKSTYL, CZARNY, PODSUFITKA: METAL, RAL 9005



SLING/ ZAWIEŚE: C.6
H55mm, 50mm, 130mm
CORD: TEXTILE, ZEBRA, CEILING ROSE: METAL, RAL 9003
PRZEWÓD: TEKSTYL, ZEBRA, PODSUFITKA: METAL, RAL 9003



SLING/ ZAWIEŚE: D.1
H55mm, 50mm, 130mm
CORD: PCV, TRANSPARENT, CEILING ROSE: METAL, RAL 7048
PRZEWÓD: PCV, PRZEJRZYSTY, PODSUFITKA: METAL, RAL 7048



SLING/ ZAWIEŚE: D.2
H55mm, 50mm, 130mm
CORD: PCV, TRANSPARENT, CEILING ROSE: METAL, RAL 9005
PRZEWÓD: PCV, PRZEJRZYSTY, PODSUFITKA: METAL, RAL 9005



SLING/ ZAWIEŚE: D.3
H55mm, 50mm, 130mm
CORD: PCV, TRANSPARENT, CEILING ROSE: METAL, RAL 9003
PRZEWÓD: PCV, PRZEJRZYSTY, PODSUFITKA: METAL, RAL 9003



SLING/ ZAWIEŚE: D.4
H55mm, 50mm, 130mm
CORD: PCV, TRANSPARENT, CEILING ROSE: METAL, RAL 6027
PRZEWÓD: PCV, PRZEJRZYSTY, PODSUFITKA: METAL, RAL 6027



SLING/ ZAWIEŚE: D.5
H55mm, 50mm, 130mm
CORD: PCV, TRANSPARENT, CEILING ROSE: METAL, RAL 5021
PRZEWÓD: PCV, PRZEJRZYSTY, PODSUFITKA: METAL, RAL 5021



SLING/ ZAWIEŚE: D.6
H55mm, 50mm, 130mm
CORD: PCV, TRANSPARENT, CEILING ROSE: METAL, RAL 3014
PRZEWÓD: PCV, PRZEJRZYSTY, PODSUFITKA: METAL, RAL 3014



SLING/ ZAWIEŚIE: E.1
H55mm, 50mm, 350mm
CORD: TEXTILE, BLACK, CEILING ROSE: METAL, RAL 9005
PRZEWÓD: TEKSTYL, CZARNY, PODSUFITKA: METAL, RAL 9005



SLING/ ZAWIEŚIE: E.2
H55mm, 50mm, 350mm
CORD: TEXTILE, ZEBRA, CEILING ROSE: METAL, RAL 9003
PRZEWÓD: TEKSTYL, ZEBRA, PODSUFITKA: METAL, RAL 9003



SLING/ ZAWIEŚIE: G.1
H55mm, 400mm, 400mm
CORD: PCV, GREY, CEILING ROSE: METAL, RAL 9003
PRZEWÓD: PCV, GREY, PODSUFITKA: METAL, RAL 9003



SLING/ ZAWIEŚIE: G.2
H55mm, 400mm, 400mm
CORD: PCV, GREY, CEILING ROSE: METAL, RAL 9003
PRZEWÓD: PCV, GREY, PODSUFITKA: METAL, RAL 9003



SLING/ ZAWIEŚIE: F.1
H55mm, 400mm, 400mm
CORD: TEXTILE, ZEBRA, CEILING ROSE: METAL, RAL 9003
PRZEWÓD: TEKSTYL, ZEBRA, PODSUFITKA: METAL, RAL 9003



SLING/ ZAWIEŚIE: F.2
H55mm, 400mm, 400mm
CORD: TEXTILE, BLACK, CEILING ROSE: METAL, RAL 9005
PRZEWÓD: TEKSTYL, CZARNY, PODSUFITKA: METAL, RAL 9005



SLING/ ZAWIEŚIE: G.3
H55mm, 400mm, 400mm
CORD: PCV, GREY, CEILING ROSE: METAL, RAL 9003
PRZEWÓD: PCV, GREY, PODSUFITKA: METAL, RAL 9003



SLING/ ZAWIEŚIE: H.1
H55mm, 400mm, 400mm
CORD: PCV, TRANSPARENT, CEILING ROSE: METAL, RAL 9003
PRZEWÓD: PCV, PRZEJRZYSTY, PODSUFITKA: METAL, RAL 9003



SLING/ ZAWIEŚIE: F.3
H55mm, 400mm, 400mm
CORD: TEXTILE, ZEBRA, CEILING ROSE: METAL, RAL 9003
PRZEWÓD: TEKSTYL, ZEBRA, PODSUFITKA: METAL, RAL 9003



SLING/ ZAWIEŚIE: F.4
H55mm, 400mm, 400mm
CORD: TEXTILE, BLACK, CEILING ROSE: METAL, RAL 9005
PRZEWÓD: TEKSTYL, CZARNY, PODSUFITKA: METAL, RAL 9005



SLING/ ZAWIEŚIE: H.2
H55mm, 400mm, 400mm
CORD: PCV, TRANSPARENT, CEILING ROSE: METAL, RAL 9003
PRZEWÓD: PCV, PRZEJRZYSTY, PODSUFITKA: METAL, RAL 9003



SLING/ ZAWIEŚIE: I.1
H90mm, 400mm, 400mm
BULB: 7xG9, CEILING ROSE: METAL, RAL 9003
ŻARÓWKA: 7xG9, PODSUFITKA: METAL, RAL 9003



SLING/ ZAWIEŚ: J.1
H55mm, 50mm, 350mm
CORD: PCV, TRANSPARENT, CEILING ROSE: METAL, RAL 7048
PRZEWÓD: PCV, PRZEJRZYSTY, PODSUFIKA: METAL, RAL 7048



SLING/ ZAWIEŚ: J.2
H55mm, 50mm, 350mm
CORD: PCV, TRANSPARENT, CEILING ROSE: METAL, RAL 7048
PRZEWÓD: PCV, PRZEJRZYSTY, PODSUFIKA: METAL, RAL 7048



SLING/ ZAWIEŚ: K.1
H55mm, 400mm, 400mm
CORD: PCV, TRANSPARENT, CEILING ROSE: METAL, RAL 9005
PRZEWÓD: PCV, PRZEJRZYSTY, PODSUFIKA: METAL, RAL 9005



SLING/ ZAWIEŚ: L.2
H90mm, 400mm, 400mm
BULB: 15xG9, CEILING ROSE: METAL, RAL 9005
ŻARÓWKA: 15xG9, PODSUFIKA: METAL, RAL 9005



SLING/ ZAWIEŚ: L.1
H90mm, 400mm, 400mm
BULB: 15xG9, CEILING ROSE: METAL, RAL 9003
ŻARÓWKA: 15xG9, PODSUFIKA: METAL, RAL 9003



SLING/ ZAWIEŚ: L.3
H90mm, 400mm, 400mm
BULB: 12xG9, CEILING ROSE: METAL, RAL 9003
ŻARÓWKA: 12xG9, PODSUFIKA: METAL, RAL 9003



SLING/ ZAWIEŚ: L.4
H90mm, 400mm, 400mm
BULB: 12xG9, CEILING ROSE: METAL, RAL 9005
ŻARÓWKA: 12xG9, PODSUFIKA: METAL, RAL 9005



SLING/ ZAWIEŚ: M.1
H90mm, 150mm, 880mm
BULB: 12xG9, CEILING ROSE: METAL, RAL 9003
ŻARÓWKA: 12xG9, PODSUFIKA: METAL, RAL 9003



SLING/ ZAWIEŚ: M.2
H90mm, 150mm, 880mm
BULB: 12xG9, CEILING ROSE: METAL, RAL 9005
ŻARÓWKA: 12xG9, PODSUFIKA: METAL, RAL 9005



SLING/ ZAWIEŚ: N.1
H55mm, 50mm, 350mm
CORD: 3xTEXTILE, BLACK, CEILING ROSE: METAL, RAL 9005
PRZEWÓD: 3xTESKTYL, CZARNY, PODSUFIKA: METAL, RAL 9005



PLUG/ WTYCZKA: A.1
CORD: TEXTILE, BLACK
PRZEWÓD: TEKSTYLNÝ, CZARNY

PLUG/ WTYCZKA: A.2
CORD: TEXTILE, ZEBRA
PRZEWÓD: TEKSTYLNÝ, ZEBRA



PLUG/ WTYCZKA: A.3
CORD: TEXTILE, GOLD
PRZEWÓD: TEKSTYLNÝ, ŻŁOTY



PLUG/ WTYCZKA: B.1
CORD: PCV, GOLD
PRZEWÓD: PCV, ŻŁOTY



PLUG/ WTYCZKA: B.2
CORD: PCV, BLACK
PRZEWÓD: PCV, CZARNY

© 2020 Gie Ei

Wyprodukowano w Polsce.

Zadna część tego katalogu
nie może być przetwarzana
w jakiegokolwiek formie, bez
wcześniejszej pisemnej
zgody Gie Ei.

Made in Poland.

No part of this catalogue may
be reproduced in any matter
without Gie Ei prior written
c o n s e n t .



Gie Ei to marka tworzona od
2012 roku przez Marię
i Jacka Rypulów, małżeństwo
polskich architektów.

Gie Ei is a brand created
since 2012 by Maria and
Jacek Rypula,
a married couple of Polish
a r c h i t e c t s .

gie el.

